



M.G. CABLE INDUSTRIES

Manufacturers : GI Cable Trays & All Earthing Materials

3/5, Ground Floor, Takwadi, Opp Yevale Tea Centre, Kalbadevi Road, Mumbai-400002. • Tel.: +91 22 4973 3629, 4913 7629

Cell : +91 96995 47310 • Email : mgcables29@gmail.com / info@mgcables.com • Website : www.mgcables.com

Authorised Stockist :



Price Schedule Retail

W.E.F. 02 FEB 2021



General Terms & Conditions

Price are subject to revision without prior notice and will be applicable as prevailing at the time of dispatch.

- This Pricelist supercedes all previous Price Lists.
- Maximum Retail Price (MRP) mentioned are maximum recommended selling prices inclusive of GST.
- All Prices are in Indian Rupees.

Warranty

All our listed products carry a warranty, against manufacturing defects for a period of 12 months from the date of invoicing subject to it's usages in normal recommended operating conditions. The company liability shall be limited to exchange or repair of the product, at its discretion, provided that such defective products are returned to billing address with all necessary documents.

POR - Price on request

Products have been classified as Stockable & Non Stockable items. Non Stockable items has been marked as 

CENTRAL CUSTOMER CARE (CCC)

Single stop Customer Support for all service needs, please contact:

Toll Free Number: 1800 572 2012

E-mail: customercare@cselectric.co.in



CONTENTS

<u>MCBs & Isolators</u>	5-8	<u>RCCBs</u>	9-11
<u>ACCL</u>	12	<u>Distribution Boards</u>	13-19
<u>Wiring Accessories</u>	20-36	<u>Industrial Plugs & Sockets</u>	37-38
<u>Control and Signaling Devices</u>	39-40	<u>Motor Starters</u>	41-42
<u>Contactors</u>	43-44	<u>MCCBs</u>	45-48
<u>Changeover Switches</u>	49-50	<u>Switch Disconnectors</u>	51
<u>Switch Disconnector Fuse Units</u>	52	<u>Fusegear</u>	53
<u>MCB Selection Chart</u>	54	<u>Customer Care Services</u>	55



WiNtrip2

MCB | RCCB



THE PROTECTOR

Life saver. Energy saver.

MCB

WIDE RANGE

0.5A~125A | B & C Curve | DC
IS/IEC-60898-1-2002
Breaking Capacity-10kA
Energy Limiting Class-3
Pollution Degree-2
Rated Frequency-50/60Hz
Accessories Mountable-Yes

SAFE

Positive Isolation | IP20 | Trip Free Mechanism

CONVENIENT

Captive Screws | Bi-Connect Terminals
Vertical-Horizontal Installation

EASY IDENTIFICATION

Legend Plate | 2 Position Dolly

HIGH PERFORMANCE

Energy Limiting Class 3 | Low Power Consumption

RCCB

WIDE RANGE

10A~100A | 30mA, 100mA, 300mA | 2P, 4P | 10kA

SAFE

IP20 | Isolation | Fire Retardant Molded-case

CONVENIENT

Dual Termination

FAST RESPONSE

Instantaneous Trip < 40ms

HIGH PERFORMANCE

Voltage Independent | No Nuisance Tripping





WiNtrip2 Miniature Circuit Breaker



B-Series

Lighting & Distribution with no Surge Current

[HSN Code: 8536]



Current rating (Amps.)	Product Code	MRP (₹)	MOQ
1 Pole			
6	CSMBS1B6	235	12
10	CSMBS1B10	235	
16	CSMBS1B16	235	
20	CSMBS1B20	235	
25	CSMBS1B25	235	
32	CSMBS1B32	235	
40	CSMBS1B40	535	
50	<input checked="" type="checkbox"/> CSMBS1B50	600	
63	CSMBS1B63	600	

Current rating (Amps.)	Product Code	MRP (₹)	MOQ
3 Pole			
6	CSMBS3B6	1200	4
10	CSMBS3B10	1200	
16	CSMBS3B16	1200	
20	CSMBS3B20	1200	
25	CSMBS3B25	1200	
32	CSMBS3B32	1200	
40	CSMBS3B40	1785	
50	<input checked="" type="checkbox"/> CSMBS3B50	1785	
63	CSMBS3B63	1785	



Current rating (Amps.)	Product Code	MRP (₹)	MOQ
1 Pole + N			
6	CSMBS1B6N	735	6
10	CSMBS1B10N	735	
16	CSMBS1B16N	735	
20	CSMBS1B20N	735	
25	CSMBS1B25N	735	
32	CSMBS1B32N	735	
40	CSMBS1B40N	1060	
50	<input checked="" type="checkbox"/> CSMBS1B50N	1200	
63	CSMBS1B63N	1200	

Current rating (Amps.)	Product Code	MRP (₹)	MOQ
3 Pole + N			
6	<input checked="" type="checkbox"/> CSMBS3B6N	1575	3
10	<input checked="" type="checkbox"/> CSMBS3B10N	1575	
16	CSMBS3B16N	1575	
20	<input checked="" type="checkbox"/> CSMBS3B20N	1575	
25	<input checked="" type="checkbox"/> CSMBS3B25N	1575	
32	CSMBS3B32N	1575	
40	CSMBS3B40N	2090	
50	<input checked="" type="checkbox"/> CSMBS3B50N	2330	
63	CSMBS3B63N	2330	



Current rating (Amps.)	Product Code	MRP (₹)	MOQ
2 Pole			
6	CSMBS2B6	810	6
10	CSMBS2B10	810	
16	CSMBS2B16	810	
20	CSMBS2B20	810	
25	CSMBS2B25	810	
32	CSMBS2B32	810	
40	CSMBS2B40	1155	
50	<input checked="" type="checkbox"/> CSMBS2B50	1325	
63	CSMBS2B63	1325	

Current rating (Amps.)	Product Code	MRP (₹)	MOQ
4 Pole			
6	<input checked="" type="checkbox"/> CSMBS4B6	1735	3
10	<input checked="" type="checkbox"/> CSMBS4B10	1735	
16	<input checked="" type="checkbox"/> CSMBS4B16	1735	
20	<input checked="" type="checkbox"/> CSMBS4B20	1735	
25	<input checked="" type="checkbox"/> CSMBS4B25	1735	
32	CSMBS4B32	1735	
40	CSMBS4B40	2270	
50	CSMBS4B50	2425	
63	CSMBS4B63	2425	

Non Stockable item



WiNtrip2 Miniature Circuit Breaker

C-Series

Inductive load with surge current - Motor Circuit Applications

[HSN Code: 8536]



Current rating (Amps.)	Product Code	MRP (₹)	MOQ
1 Pole			
0.5	<input checked="" type="checkbox"/> CSMBS1C0.5	410	12
1	CSMBS1C1	410	
2	CSMBS1C2	410	
3	<input checked="" type="checkbox"/> CSMBS1C3	410	
4	CSMBS1C4	410	
5	<input checked="" type="checkbox"/> CSMBS1C5	410	
6	CSMBS1C6	245	
10	CSMBS1C10	245	
16	CSMBS1C16	245	
20	CSMBS1C20	245	
25	CSMBS1C25	245	
32	CSMBS1C32	245	
40	CSMBS1C40	570	
50	<input checked="" type="checkbox"/> CSMBS1C50	610	
63	CSMBS1C63	610	

Current rating (Amps.)	Product Code	MRP (₹)	MOQ
3 Pole			
0.5	<input checked="" type="checkbox"/> CSMBS3C0.5	1585	4
1	<input checked="" type="checkbox"/> CSMBS3C1	1585	
2	CSMBS3C2	1585	
3	<input checked="" type="checkbox"/> CSMBS3C3	1585	
4	<input checked="" type="checkbox"/> CSMBS3C4	1585	
5	CSMBS3C5	1585	
6	CSMBS3C6	1270	
10	CSMBS3C10	1270	
16	CSMBS3C16	1270	
20	CSMBS3C20	1270	
25	CSMBS3C25	1270	
32	CSMBS3C32	1270	
40	CSMBS3C40	1880	
50	CSMBS3C50	1965	
63	CSMBS3C63	1965	



Current rating (Amps.)	Product Code	MRP (₹)	MOQ
1 Pole + N			
0.5	CSMBS1C0.5N	1095	6
1	<input checked="" type="checkbox"/> CSMBS1C1N	1095	
2	<input checked="" type="checkbox"/> CSMBS1C2N	1095	
3	<input checked="" type="checkbox"/> CSMBS1C3N	1095	
4	CSMBS1C4N	1095	
5	CSMBS1C5N	1095	
6	<input checked="" type="checkbox"/> CSMBS1C6N	780	
10	CSMBS1C10N	780	
16	CSMBS1C16N	780	
20	CSMBS1C20N	780	
25	<input checked="" type="checkbox"/> CSMBS1C25N	780	
32	CSMBS1C32N	780	
40	<input checked="" type="checkbox"/> CSMBS1C40N	1135	
50	<input checked="" type="checkbox"/> CSMBS1C50N	1280	
63	CSMBS1C63N	1280	

Current rating (Amps.)	Product Code	MRP (₹)	MOQ
3 Pole + N			
0.5	CSMBS3C0.5N	2050	3
1	CSMBS3C1N	2050	
2	<input checked="" type="checkbox"/> CSMBS3C2N	2050	
3	CSMBS3C3N	2050	
4	CSMBS3C4N	2050	
5	CSMBS3C5N	2050	
6	CSMBS3C6N	1610	
10	<input checked="" type="checkbox"/> CSMBS3C10N	1610	
16	CSMBS3C16N	1610	
20	CSMBS3C20N	1610	
25	CSMBS3C25N	1610	
32	CSMBS3C32N	1610	
40	CSMBS3C40N	2195	
50	<input checked="" type="checkbox"/> CSMBS3C50N	2320	
63	CSMBS3C63N	2320	



Current rating (Amps.)	Product Code	MRP (₹)	MOQ
2 Pole			
0.5	CSMBS2C0.5	1145	6
1	<input checked="" type="checkbox"/> CSMBS2C1	1145	
2	CSMBS2C2	1145	
3	<input checked="" type="checkbox"/> CSMBS2C3	1145	
4	CSMBS2C4	1145	
5	CSMBS2C5	1145	
6	CSMBS2C6	815	
10	CSMBS2C10	815	
16	CSMBS2C16	815	
20	CSMBS2C20	815	
25	CSMBS2C25	815	
32	CSMBS2C32	815	
40	CSMBS2C40	1200	
50	<input checked="" type="checkbox"/> CSMBS2C50	1365	
63	CSMBS2C63	1365	

Current rating (Amps.)	Product Code	MRP (₹)	MOQ
4 Pole			
0.5	CSMBS4C0.5	2185	3
1	CSMBS4C1	2185	
2	<input checked="" type="checkbox"/> CSMBS4C2	2185	
3	CSMBS4C3	2185	
4	<input checked="" type="checkbox"/> CSMBS4C4	2185	
5	CSMBS4C5	2185	
6	CSMBS4C6	1785	
10	CSMBS4C10	1785	
16	CSMBS4C16	1785	
20	CSMBS4C20	1785	
25	CSMBS4C25	1785	
32	CSMBS4C32	1785	
40	CSMBS4C40	2450	
50	CSMBS4C50	2530	
63	CSMBS4C63	2530	

Non Stockable item



WiNtrip2 Miniature Circuit Breaker

Accessories (Site fit-able)							[HSN Code: 8538]
Description	Product Code	Configuration	Type of contact	Fitment	Module Size	Suitable MCB Rating (A)	MRP (₹)
Auxiliary Contact	CSMBAXSF1	1NO-1NC	Changeover	Right	9 mm	Wintrip2 0.5-63	935
Auxiliary Contact	CSMBAXSF2	2NO-2NC	Changeover	Right	9 mm	Wintrip2 0.5-63	970
Auxiliary Contact	CSMBAXSF11	1NO-1NC	Potential free	Left	18 mm	Wintrip2 0.5-63	935
Alarm Contact	CSMBALSF1	1 Changeover	Changeover	Right	9 mm	Wintrip2 0.5-63	830
Shunt Trip	CSMBS012DCSF	-	-	Left	18 mm	Wintrip2 0.5-63	1105
Shunt Trip	CSMBS024DCSF	-	-	Left	18 mm	Wintrip2 0.5-63	1105
Shunt Trip	CSMBS048DCSF	-	-	Left	18 mm	Wintrip2 0.5-63	1105
Shunt Trip	CSMBS220ACSF	-	-	Left	18 mm	Wintrip2 0.5-63	1105

DC MCB-Series

[HSN Code: 8536]

Current rating (Amps.)	Product Code	MRP (₹)	MOQ
1 Pole			
0.5	<input checked="" type="checkbox"/> CSMBS1DC0.5	530	12
1	<input checked="" type="checkbox"/> CSMBS1DC1	530	
2	<input checked="" type="checkbox"/> CSMBS1DC2	530	
3	CSMBS1DC3	530	
4	<input checked="" type="checkbox"/> CSMBS1DC4	530	
5	<input checked="" type="checkbox"/> CSMBS1DC5	530	
6	CSMBS1DC6	460	
10	<input checked="" type="checkbox"/> CSMBS1DC10	460	
16	<input checked="" type="checkbox"/> CSMBS1DC16	460	
20	<input checked="" type="checkbox"/> CSMBS1DC20	460	
25	<input checked="" type="checkbox"/> CSMBS1DC25	460	
32	<input checked="" type="checkbox"/> CSMBS1DC32	460	
40	<input checked="" type="checkbox"/> CSMBS1DC40	645	
50	<input checked="" type="checkbox"/> CSMBS1DC50	745	
63	<input checked="" type="checkbox"/> CSMBS1DC63	745	

Current rating (Amps.)	Product Code	MRP (₹)	MOQ
2 Pole			
0.5	CSMBS2DC0.5	1240	6
1	CSMBS2DC1	1240	
2	<input checked="" type="checkbox"/> CSMBS2DC2	1240	
3	CSMBS2DC3	1240	
4	CSMBS2DC4	1240	
5	CSMBS2DC5	1240	
6	CSMBS2DC6	965	
10	CSMBS2DC10	965	
16	CSMBS2DC16	965	
20	CSMBS2DC20	965	
25	CSMBS2DC25	965	
32	CSMBS2DC32	965	
40	<input checked="" type="checkbox"/> CSMBS2DC40	1345	
50	<input checked="" type="checkbox"/> CSMBS2DC50	1515	
63	CSMBS2DC63	1515	



WiNtrip2 Isolator

[HSN Code: 8536]

Current rating (Amps.)	Product Code	MRP (₹)	MOQ
1 Pole			
25	<input checked="" type="checkbox"/> CSMB1ISO25	265	12
40	<input checked="" type="checkbox"/> CSMB1ISO40	350	
63	<input checked="" type="checkbox"/> CSMB1ISO63	385	
80	CSMB1ISO80	425	
100	<input checked="" type="checkbox"/> CSMB1ISO100	500	
125	<input checked="" type="checkbox"/> CSMB1ISO125	585	

Current rating (Amps.)	Product Code	MRP (₹)	MOQ
3 Pole			
25	CSMBS3ISO25	810	4
40	CSMBS3ISO40	935	
63	CSMBS3ISO63	1040	
80	<input checked="" type="checkbox"/> CSMBS3ISO80	1200	
100	CSMBS3ISO100	1230	
125	<input checked="" type="checkbox"/> CSMBS3ISO125	1305	



Current rating (Amps.)	Product Code	MRP (₹)	MOQ
2 Pole			
25	CSMBS2ISO25	435	6
40	CSMBS2ISO40	480	
63	CSMBS2ISO63	615	
80	<input checked="" type="checkbox"/> CSMBS2ISO80	775	
100	CSMBS2ISO100	795	
125	CSMBS2ISO125	890	

Current rating (Amps.)	Product Code	MRP (₹)	MOQ
4 Pole			
25	<input checked="" type="checkbox"/> CSMBS4ISO25	860	3
40	CSMBS4ISO40	1060	
63	CSMBS4ISO63	1170	
80	<input checked="" type="checkbox"/> CSMBS4ISO80	1445	
100	CSMBS4ISO100	1465	
125	CSMBS4ISO125	1615	



For WiNtrip MCB / Isolator prices please contact nearest Branch Office.

Non Stockable item



Higher Rating Miniature Circuit Breakers

[HSN Code: 8536]



Current rating (Amps.)	Product Code	MRP (₹)	MOQ
1 Pole			
80	CSMBH1C80	2175	3
100	CSMBH1C100	2440	
125	CSMBH1C125	2640	
2 Pole			
80	CSMBH2C80	4830	3
100	CSMBH2C100	5160	
125	CSMBH2C125	5670	

Current rating (Amps.)	Product Code	MRP (₹)	MOQ
3 Pole			
80	CSMBH3C80	7625	1
100	CSMBH3C100	8120	
125	CSMBH3C125	9020	
4 Pole			
80	CSMBH4C80	9705	1
100	CSMBH4C100	10115	
125	CSMBH4C125	11425	

Accessories (Site fit-able)

[HSN Code: 8538]

Description	Product Code	Configuration	Type of contact	Fitment	Module Size	Suitable MCB Rating (A)	MRP (₹)
Auxiliary Contact	CSMBAXHSF1	1NO-1NC	Changeover	Right	9 mm	Wintrip2 80-100	1050
Auxiliary Contact	CSMBAXHSF2	2NO-2NC	Changeover	Right	9 mm	Wintrip2 80-100	1085
Alarm Contact	CSMBALHSF1	1 Changeover	Changeover	Right	9 mm	Wintrip2 80-100	1050
Shunt Trip	CSMBHS012DCSF	-	-	Left	18 mm	Wintrip2 80-100	1230
Shunt Trip	CSMBHS024DCSF	-	-	Left	18 mm	Wintrip2 80-100	1230
Shunt Trip	CSMBHS048DCSF	-	-	Left	18 mm	Wintrip2 80-100	1230
Shunt Trip	CSMBHS220ACSF	-	-	Left	18 mm	Wintrip2 80-100	1230

Wintrip MCB Type Changeover Switch

[HSN Code: 8536]



Description	Pole	Rating (Amps.)	Product Code	MRP (₹)	MOQ
2 Pole					
Two way centre OFF Changeover Switch	2	25	CSCOS2P25A	1560	6
Two way centre OFF Changeover Switch	2	40	CSCOS2P40A	2315	
Two way centre OFF Changeover Switch	2	63	CSCOS2P63A	2685	

[HSN Code: 8536]



Description	Pole	Rating (Amps.)	Product Code	MRP (₹)	MOQ
4 Pole					
Two way centre OFF Changeover Switch	4	25	CSCOS4P25A	2950	3
Two way centre OFF Changeover Switch	4	40	CSCOS4P40A	4420	
Two way centre OFF Changeover Switch	4	63	CSCOS4P63A	4740	

SmartSol Mini MCB DP

[HSN Code: 8536]



Description	Current rating (Amps.)	Reference	MRP (₹)
DP "C" 6-32A Mini MCB with Enclosure	6-32	CSMBSS2C6-32	540
SPN "C" 6-32A Mini MCB with Enclosure	6-32	CSMBSS1C6-32*N	525

 Non Stockable item



WiNtrip RCCBs

Safety isn't expensive, it's PRICELESS! C&S RCCBs 10kA



IS 12640-1-2008



CM/L:3148552

- WIDE RANGE**
10A~100A | 30mA, 100mA, 300mA | 2P, 4P | 10kA
- SAFE**
IP20 | Isolation | Fire Retardant Molded-case
- CONVENIENT**
Dual Termination
- FAST RESPONSE**
Instantaneous Trip<40ms
- HIGH PERFORMANCE**
Voltage Independent | No Nuisance Tripping



CE | KEMA  | RoHS Compliant
IEC/EN 61008-1

WiNtrip Residual Current Circuit Breaker

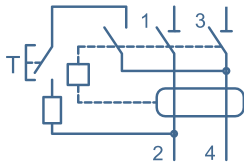

Test Button



Bi-connect Terminals

2 Pole, 30mA 10kA			[HSN Code: 8536]
Current rating (Amps.)	Product Code	MRP (₹)	MOQ
10	CSRB2P10A30-10kA	2920	6
16	CSRB2P16A30-10kA	2920	
20	<input checked="" type="checkbox"/> CSRB2P20A30-10kA	2920	
25	CSRB2P25A30-10kA	3015	
32	CSRB2P32A30-10kA	3080	
40	CSRB2P40A30-10kA	3100	
63	CSRB2P63A30-10kA	4140	
80	<input checked="" type="checkbox"/> CSRB2P80A30-10kA	6175	
100	<input checked="" type="checkbox"/> CSRB2P100A30-10kA	6210	

2 Pole, 100mA 10kA			[HSN Code: 8536]
Current rating (Amps.)	Product Code	MRP (₹)	MOQ
10	<input checked="" type="checkbox"/> CSRB2P10A100-10kA	2920	6
16	CSRB2P16A100-10kA	2920	
20	<input checked="" type="checkbox"/> CSRB2P20A100-10kA	2920	
25	CSRB2P25A100-10kA	3015	
32	CSRB2P32A100-10kA	3080	
40	CSRB2P40A100-10kA	3100	
63	CSRB2P63A100-10kA	4140	
80	CSRB2P80A100-10kA	6175	
100	<input checked="" type="checkbox"/> CSRB2P100A100-10kA	6210	

2 Pole, 300mA 10kA			[HSN Code: 8536]
Current rating (Amps.)	Product Code	MRP (₹)	MOQ
10	CSRB2P10A300-10kA	2930	6
16	<input checked="" type="checkbox"/> CSRB2P16A300-10kA	2930	
20	CSRB2P20A300-10kA	2940	
25	CSRB2P25A300-10kA	3165	
32	<input checked="" type="checkbox"/> CSRB2P32A300-10kA	3205	
40	<input checked="" type="checkbox"/> CSRB2P40A300-10kA	3395	
63	<input checked="" type="checkbox"/> CSRB2P63A300-10kA	4255	
80	<input checked="" type="checkbox"/> CSRB2P80A300-10kA	6210	
100	CSRB2P100A300-10kA	6240	

Non Stockable item



WiNtrip Residual Current Circuit Breaker



4 Pole, 30mA 10kA			[HSN Code: 8536]
Current rating (Amps.)	Product Code	MRP (₹)	MOQ
10	<input checked="" type="checkbox"/> CSRB4P10A30-10kA	3635	3
16	CSRB4P16A30-10kA	3655	
20	<input checked="" type="checkbox"/> CSRB4P20A30-10kA	3690	
25	CSRB4P25A30-10kA	3865	
32	CSRB4P32A30-10kA	3875	
40	CSRB4P40A30-10kA	3960	
63	CSRB4P63A30-10kA	4505	
80	CSRB4P80A30-10kA	6805	
100	<input checked="" type="checkbox"/> CSRB4P100A30-10kA	6985	

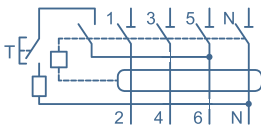

4 Pole, 100mA 10kA			[HSN Code: 8536]
Current rating (Amps.)	Product Code	MRP (₹)	MOQ
10	<input checked="" type="checkbox"/> CSRB4P10A100-10kA	3635	3
16	<input checked="" type="checkbox"/> CSRB4P16A100-10kA	3655	
20	CSRB4P20A100-10kA	3690	
25	CSRB4P25A100-10kA	3865	
32	CSRB4P32A100-10kA	3875	
40	CSRB4P40A100-10kA	3960	
63	CSRB4P63A100-10kA	4505	
80	CSRB4P80A100-10kA	6805	
100	CSRB4P100A100-10kA	6985	



Test Button



Bi-connect Terminals

4 Pole, 300mA 10kA			[HSN Code: 8536]
Current rating (Amps.)	Product Code	MRP (₹)	MOQ
10	<input checked="" type="checkbox"/> CSRB4P10A300-10kA	3655	3
16	<input checked="" type="checkbox"/> CSRB4P16A300-10kA	3680	
20	CSRB4P20A300-10kA	3710	
25	<input checked="" type="checkbox"/> CSRB4P25A300-10kA	4045	
32	<input checked="" type="checkbox"/> CSRB4P32A300-10kA	4050	
40	CSRB4P40A300-10kA	4215	
63	CSRB4P63A300-10kA	4530	
80	<input checked="" type="checkbox"/> CSRB4P80A300-10kA	6850	
100	CSRB4P100A300-10kA	7025	

NOTE:

1. MCB in bulk packing are available on request.
2. The industrial MCB will have non-retail (NR) suffix in their part codes.
3. For MCB technical Data sheet, Dimesion details etc. please refer product catalogue or contact nearest Branch Office.

Non Stockable item



ACCL

Automatic Changeover with Current Limiter

- Complying to IEC 60947-6 & IEC 60947-3
- Utilization Category AC 32A
- Rating : Mains - 30A, DG - 0.5A~30A
- Individual LED for Mains & DG
- Quick transfer time
- Fault Annunciation
- Higher electrical life
- Low blackout time
- Din Rail mounting
- Auto Reset facility
- Can be used for new installations as well as for retrofits

ACCL			[HSN Code: 8536]
Product Code	Mains Rating (Amps.)	Genset Rating (Amps.)	MRP (₹)
TCALSS005	30	0.5	3430
TCALSS010	30	1	3430
TCALSS015	30	1.5	3430
TCALSS025	30	2.5	3430
TCALSS030	30	3	3430
TCALSS040	30	4	3430
TCALSS050	30	5	3430
TCALSS060	30	6	3430
TCALSS080	30	8	3430
TCALSS090	30	9	3430
TCALSS100	30	10	3430
TCALSS150	30	15	3430
TCALSS200	30	20	3430
TCALSS250	30	25	3430
TCALSS300	30	30	3430

 Non Stockable item



Distribution Boards



New

Epitome IP43 Distribution Boards

for household & industrial applications

- Heavy Duty Gasket to inhibit the entry of foreign particles
- Choice of multiple incomers as MCB/Isolator/RCCB
- Adequate wiring space
- Also Available with lock & key mechanism for safety

EPITOME IP43 Distribution Boards			[HSN Code: 8537]
Description	Product Code	No. of Modules (Incomer+Outgoing)	MRP (₹)
SPN Distribution Boards			
SPN Double Door 04 Way IP43 DB	CSDBSPNPWXDD04	4	1930
SPN Double Door 06 Way IP43 DB	CSDBSPNPWXDD06	6	2260
SPN Double Door 08 Way IP43 DB	CSDBSPNPWXDD08	8	2435
SPN Double Door 10 Way IP43 DB	CSDBSPNPWXDD10	10	2935
SPN Double Door 12 Way IP43 DB	CSDBSPNPWXDD12	12	3090
SPN Double Door 16 Way IP43 DB	CSDBSPNPWXDD16	16	3935
SPN Double Door 20 Way IP43 DB	CSDBSPNPWXDD20	20	5310
SPN Double Door 24 Way IP43 DB	CSDBSPNPWXDD24	24	6020
TPN Distribution Boards			
TPNH Double Door 04 Way IP43 DB	CSDBTPNHPWXDD04	8+12	5200
TPNH Double Door 06 Way IP43 DB	CSDBTPNHPWXDD06	8+18	6500
TPNH Double Door 08 Way IP43 DB	CSDBTPNHPWXDD08	8+24	8070
TPNH Double Door 12 Way IP43 DB	CSDBTPNHPWXDD12	8+36	10935
TPNH Double Door 16 Way IP43 DB	CSDBTPNHPWXDD16	8+48	14260

 Non Stockable item



EPiC ^{New} Distribution Boards

- SPN Single Door Distribution Board
- SPN Double Door Distribution Board
- TPN Horizontal Single Door Distribution Board
- TPN Horizontal Double Door Distribution Board
- TPN Vertical Double Door Distribution Board

EPiC Distribution Boards

[HSN Code: 8537]



Description	Product Code	Total Modules	MRP (₹)
SPN Distribution Boards			
04 WAY SPN Single Door	CSDBSPNPESD04	4	885
06 WAY SPN Single Door	CSDBSPNPESD06	6	960
08 WAY SPN Single Door	CSDBSPNPESD08	8	1135
12 WAY SPN Single Door	CSDBSPNPESD12	12	1450
16 WAY SPN Single Door	CSDBSPNPESD16	16	1855
SPN Distribution Boards			
04 WAY SPN Double Door	CSDBSPNPEDD04	4	1475
06 WAY SPN Double Door	CSDBSPNPEDD06	6	1585
08 WAY SPN Double Door	CSDBSPNPEDD08	8	1835
10 WAY SPN Double Door	CSDBSPNPEDD10	10	2225
12 WAY SPN Double Door	CSDBSPNPEDD12	12	2420
16 WAY SPN Double Door	CSDBSPNPEDD16	16	3010
TPN-Horizontal Distribution Boards			
04 WAY TPNH Single Door	CSDBTPNHPSD04	20	2790
06 WAY TPNH Single Door	CSDBTPNHPSD06	26	3490
08 WAY TPNH Single Door	CSDBTPNHPSD08	32	4090
12 WAY TPNH Single Door	CSDBTPNHPSD12	44	5515
TPN-Horizontal Distribution Boards			
04 WAY TPNH Double Door	CSDBTPNHPEDD04	20	4035
06 WAY TPNH Double Door	CSDBTPNHPEDD06	26	4970
08 WAY TPNH Double Door	CSDBTPNHPEDD08	32	5955
12 WAY TPNH Double Door	CSDBTPNHPEDD12	44	8110
TPN-Vertical Distribution Boards			
04 WAY TPNH Double Door	CSDBTPNVPEDD04	20	7435
06 WAY TPNH Double Door	CSDBTPNVPEDD06	26	8810
08 WAY TPNH Double Door	CSDBTPNVPEDD08	32	10250
12 WAY TPNH Double Door	CSDBTPNVPEDD12	44	13080



C&S Distribution Boards			[HSN Code: 8537]
Description	Product Code	No. of Modules (Incomer+Outgoing)	MRP (₹)
SPN Distribution Boards			
04 WAY SPN Single Door	CSDBSPNPESD04	4	895
06 WAY SPN Single Door	CSDBSPNPESD06	6	985
08 WAY SPN Single Door	CSDBSPNPESD08	8	1135
12 WAY SPN Single Door	CSDBSPNPESD12	12	1485
16 WAY SPN Single Door	CSDBSPNPESD16	16	1940
SPN Distribution Boards			
04 WAY SPN Double Door	CSDBSPNPDD04	4	1475
06 WAY SPN Double Door	CSDBSPNPDD06	6	1650
08 WAY SPN Double Door	CSDBSPNPDD08	8	1865
10 WAY SPN Double Door	CSDBSPNPDD10	10	2270
12 WAY SPN Double Door	CSDBSPNPDD12	12	2465
16 WAY SPN Double Door	CSDBSPNPDD16	16	3075
TPN-Horizontal Distribution Boards			
04 WAY TPNH Single Door	CSDBTPNHPSD04	8+12	2880
06 WAY TPNH Single Door	CSDBTPNHPSD06	8+18	3600
08 WAY TPNH Single Door	CSDBTPNHPSD08	8+24	4190
12 WAY TPNH Single Door	CSDBTPNHPSD12	8+36	5650
TPN-Horizontal Distribution Boards			
04 WAY TPNH Double Door	CSDBTPNHPDD04	8+12	4035
06 WAY TPNH Double Door	CSDBTPNHPDD06	8+18	5025
08 WAY TPNH Double Door	CSDBTPNHPDD08	8+24	6140
12 WAY TPNH Double Door	CSDBTPNHPDD12	8+36	8600

CSDBTPNHPSD06, CSDBTPNHPSD08, CSDBTPNHPSD12, CSDBTPNHPDD06, CSDBTPNHPDD08, CSDBTPNHPDD12 are non stockable items.

Distribution Boards



C&S WiNclass Distribution Boards (Deepdrawn)

SPN WiNclass Distribution Boards			[HSN Code: 8537]
Description	Product Code	No. of Modules (Incomer+Outgoing)	MRP (₹)
2+04 Way Single Door	CSDBSPNSD04S	2+04	1170
2+08 Way Single Door	CSDBSPNSD08S	2+08	1465
2+12 Way Single Door	CSDBSPNSD12S	2+12	2005
2+14 Way Single Door	CSDBSPNSD16S	2+14	2500
2+04 Way Double Door	CSDBSPNDD04S	2+04	1905
2+08 Way Double Door	CSDBSPNDD08S	2+08	2365
2+12 Way Double Door	CSDBSPNDD12S	2+12	3095
2+14 Way Double Door	CSDBSPNDD16S	2+14	4050
TPN WiNclass Distribution Boards			
04 Way Single Door DB	<input checked="" type="checkbox"/> CSDBTPNHSD04S	8+12	3815
06 Way Single Door DB	<input checked="" type="checkbox"/> CSDBTPNHSD06S	8+18	4570
08 Way Single Door DB	<input checked="" type="checkbox"/> CSDBTPNHSD08S	8+24	5020
12 Way Single Door DB	<input checked="" type="checkbox"/> CSDBTPNHSD12S	8+36	6630
16 Way Single Door DB	<input checked="" type="checkbox"/> CSDBTPNHSD16S	8+48	8305
04 Way Double Door DB	CSDBTPNHDD04SN	4+12	5010
04 Way Double Door DB	CSDBTPNHDD04S	8+12	5065
06 Way Double Door DB	CSDBTPNHDD06S	8+18	6335
08 Way Double Door DB	CSDBTPNHDD08S	8+24	7980
12 Way Double Door DB	CSDBTPNHDD12S	8+36	11365
16 Way Double Door DB	<input checked="" type="checkbox"/> CSDBTPNHDD16S	8+48	14335



WiNtrip Distribution Boards

Distribution Boards (Deepdrawn with Pan Assembly)			[HSN Code: 8537]
SPN Distribution Boards			
Description	Product Code	No. of Modules (Incomer+Outgoing)	MRP (₹)
04 Way Single Door	<input checked="" type="checkbox"/> CSDBSPNSD04	4	1620
08 Way Single Door	<input checked="" type="checkbox"/> CSDBSPNSD08	8	2040
12 Way Single Door	<input checked="" type="checkbox"/> CSDBSPNSD12	12	2420
16 Way Single Door	<input checked="" type="checkbox"/> CSDBSPNSD16	16	3030
04 Way Double Door	CSDBSPNDD04	4	2275
08 Way Double Door	CSDBSPNDD08	8	2815
12 Way Double Door	CSDBSPNDD12	12	3400
16 Way Double Door	<input checked="" type="checkbox"/> CSDBSPNDD16	16	4265
TPN Distribution Boards - Horizontal			
04 Way Single Door	<input checked="" type="checkbox"/> CSDBTPNHSD04	8+12	4335
06 Way Single Door	<input checked="" type="checkbox"/> CSDBTPNHSD06	8+18	5425
08 Way Single Door	<input checked="" type="checkbox"/> CSDBTPNHSD08	8+24	6450
12 Way Single Door	<input checked="" type="checkbox"/> CSDBTPNHSD12	8+36	9430
16 Way Single Door	<input checked="" type="checkbox"/> CSDBTPNHSD16	8+48	11520
04 Way Double Door	CSDBTPNHDD04	8+12	5740
06 Way Double Door	CSDBTPNHDD06	8+18	7100
08 Way Double Door	CSDBTPNHDD08	8+24	8505
12 Way Double Door	<input checked="" type="checkbox"/> CSDBTPNHDD12	8+36	12680
16 Way Double Door	<input checked="" type="checkbox"/> CSDBTPNHDD16	8+48	15505



Polycarbonate Cover Consumer Unit DBs			[HSN Code: 8537]
Description	Product Code	No. of Modules (Incomer+Outgoing)	MRP (₹)
SPN WC 06 WAY SD WITH ACRYLIC DOOR	CSDBSPNSDCA06	6	1705
SPN WC 08 WAY SD WITH ACRYLIC DOOR	CSDBSPNSDCA08	8	1905
SPN WC 12 WAY SD WITH ACRYLIC DOOR	CSDBSPNSDCA12	12	2455
SPN WC 16 WAY SD WITH ACRYLIC DOOR	CSDBSPNSDCA16	16	3125



non stockable items.







Distribution Boards

WiNtrip Distribution Boards



Double Door DBs (with Acrylic Window)		[HSN Code: 8537]
Description	Product Code	MRP (₹)
SPN Distribution Board Double Door 4 Way	CSDBSPNDDA2+04	2390
SPN Distribution Board Double Door 8 Way	CSDBSPNDDA2+08	2805
SPN Distribution Board Double Door 12 Way	CSDBSPNDDA2+12	3415
SPN Distribution Board Double Door 16 Way	CSDBSPNDDA2+14	4220



Phase Selector Distribution Boards - TPN Phase Selector DD DB for incorporating MCB / Isolator / RCCB, equipped with 3 Nos 63A Phase Selector Switches & 3 No Piano Switches		[HSN Code: 8537]
Description	Product Code	MRP (₹)
4 Way DD with 63A Rotary Switch	CSDBPHSCDD04RS63	17825
6 Way DD with 63A Rotary Switch	CSDBPHSCDD06RS63	18240
8 Way DD with 63A Rotary Switch	CSDBPHSCDD08RS63	20125
12 Way DD with 63A Rotary Switch	 CSDBPHSCDD12RS63	22295
4 Way DD with 40A Rotary Switch	CSDBPHSCDD04RS40	17715
6 Way DD with 40A Rotary Switch	CSDBPHSCDD06RS40	17920
8 Way DD with 40A Rotary Switch	 CSDBPHSCDD08RS40	19940
12Way DD with 40A Rotary Switch	 CSDBPHSCDD12RS40	21920
4 Way DD without Rotary Switch	 CSDBPHSCDD04	15240
6 Way DD without Rotary Switch	 CSDBPHSCDD06	15620
8 Way DD without Rotary Switch	CSDBPHSCDD08	17190
12 Way DD without Rotary Switch	CSDBPHSCDD12	19635



VTPN Distribution Boards (with provision for WiNtrip2 MCB)			[HSN Code: 8537]
Description	Product Code	No. of Modules (Incomer+Outgoing)	MRP (₹)
4 way Double Door	CSDBTPNVDD04S	8+12	12985
6 way Double Door	CSDBTPNVDD06S	8+18	14875
8 way Double Door	CSDBTPNVDD08S	8+24	16450
12 way Double Door	CSDBTPNVDD12S	8+36	22030



VTPN Distribution Boards (with provision for WiNbreak MCCB as incomer & WiNtrip2 MCB as outgoing)			[HSN Code: 8537]
Description	Product Code	MRP (₹)	
MCCB as incomer 100A DD04 Way IP43	CSDBMCCB100DD04IP43S	15940	
MCCB as incomer 100A DD08 Way IP43	CSDBMCCB100DD08IP43S	20255	
MCCB as incomer 100A DD12 Way IP43	CSDBMCCB100DD12IP43S	27035	
MCCB as incomer 250A DD04 Way IP43	 CSDBMCCB225DD04IP43S	28300	
MCCB as incomer 250A DD08 Way IP43	CSDBMCCB225DD08IP43S	33300	
MCCB as incomer 250A DD12 Way IP43	CSDBMCCB225DD12IP43S	34785	





VTPN Distribution Boards (with provision for MCCB WiNbreak1 as incomer & WiNtrip2 MCB as outgoing)			[HSN Code: 8537]
Description	Product Code	MRP (₹)	
DB MCCB AS I/C 100A DD04 WAY IP43	CSDBMCCB125PDD04S	13780	
DB MCCB AS I/C 100A DD08 WAY IP43	CSDBMCCB125PDD08S	15515	
DB MCCB AS I/C 100A DD12 WAY IP43	CSDBMCCB125PDD12S	21455	
DB MCCB AS I/C 250A DD04 WAY IP43	 CSDBMCCB250PDD04S	16535	
DB MCCB AS I/C 250A DD08 WAY IP43	CSDBMCCB250PDD08S	21540	
DB MCCB AS I/C 250A DD12 WAY IP43	CSDBMCCB250PDD12S	26905	







 non stockable items.



Distribution Boards

WiNtrip Distribution Boards

Selection Table for MCCB as Incomer VTPN Distribution Boards							
	Description	Product Code	Type/ Breaking Capacity Ics=100%Icu	MCCB Rating			
 WINbreak MCCB	CS2A3* CS2A4* CSC1S3* CSC1S4* CSC2N3* CSC2N4*	CSDBMCCB100DD04IP43S CSDBMCCB100DD08IP43S CSDBMCCB100DD12IP43S	CS2A=10kA CSC1S=18kA CSC2N=18kA	15, 20, 30, 40, 50, 60, 75 & 100A			
	CSC4N3* CSC4N4* CSC4S3* CSC4S4*	CSDBMCCB225DD04IP43S CSDBMCCB225DD08IP43S CSDBMCCB225DD12IP43S			CSC4N=26kA	100, 125, 150, 175 200 & 250A	
					CSC4S=37kA	150, 175, 200 & 250A	
	 WINbreak 1 MCCB	CSE1M125ATM3P-*, CSE1M125ATM4P-* CSE1NN125ATM3P-*, CSE1NN125ATM4P-* CSE1NN125ETM3P-*, CSE1NN125ETM4P-* CSE1S125ETM3P-*, CSE1S125ETM4P-*	CSDBMCCB125PDD04S CSDBMCCB125PDD08S CSDBMCCB125PDD12S	25kA, 36kA & 50kA	15, 20, 30, 40, 50, 60, 75 & 100A		
		CSE2M250ATM3P-*, CSE2M250A M4P-*, CSE2NN250ATM3P-*, CSE2NN250ATM4P-* CSE2NN250ETM3P-*, CSE2NN250ETM4P-* CSE2S250ETM3P-*, CSE2S250ETM4P-* CSE2SX250ETM3P-*, CSE2SX250ETM4P-* CSE2SX250ATM3P-*, CSE2SX250ATM4P-*	CSDBMCCB250PDD04S CSDBMCCB250PDD08S CSDBMCCB250PDD12S			25kA, 36kA & 50kA	160, 200, 250 & 63-160 80-100, 100-250
NOTE: While Ordering, Replace "*" by current Rating.							

WiNtrip Telephone & Television Socket Distribution Boards			[HSN Code: 8537]
Description	Product Code	MRP (₹)	
SPN 04 way Tel & TV Socket DB (2+4)	 CSDBSPNDDTELV04	4110	
SPN 06 way Tel & TV Socket DB (2+6)	CSDBSPNDDTELV06	4360	
SPN 08 way Tel & TV Socket DB (2+8)	 CSDBSPNDDTELV08	4625	
SPN 10 way Tel & TV Socket DB (2+10)	 CSDBSPNDDTELV10	4930	
SPN 12 way Tel & TV Socket DB (2+12)	 CSDBSPNDDTELV12	5485	
SPN 14 way Tel & TV Socket DB (2+14)	 CSDBSPNDDTELV14	5660	
TPN 04 way Tel & TV Socket DB (8+12)	CSDBTPNDDTELV04	6825	
TPN 06 way Tel & TV Socket DB (8+18)	CSDBTPNDDTELV06	7830	
TPN 08 way Tel & TV Socket DB (8+24)	 CSDBTPNDDTELV08	9025	
TPN 12 way Tel & TV Socket DB (8+36)	 CSDBTPNDDTELV12	11750	





Plug and Socket DBs



WiNtrip Plug and Socket DBs (without MCB) [HSN Code: 8537]			
Powder Coated Sheet Metal Deep Drawn DBs with Plug & Socket including insulated Neutral link, adjustable Din Rail and connecting links.			
Description	Product Code	MRP (₹)	MOQ
10Amp SPN	 CSDBPSSPN010	1200	12
20Amp SPN	CSDBPSSPN020	1200	12
20Amp SPN (SP Cutout)	CSDBPSSPN020SP	1200	12
20Amp TPN	CSDBPSTPN020	3185	6
30Amp TPN	CSDBPSTPN030	3185	6



WiNtrip Plug and Sockets (Metal Clad) [HSN Code: 8537]			
Description	Product Code	MRP (₹)	MOQ
10Amp SPN Plug	CSDBPSPN010	255	36
10Amp SPN Socket	CSDBSSPN010	255	36
20Amp SPN Plug	CSDBPSPN020	265	36
20Amp SPN Socket	CSDBSSPN020	285	36
20Amp TPN Plug	CSDBPTPN020	340	36
20Amp TPN Socket	CSDBSTPN020	350	36
30Amp TPN Plug	CSDBPTPN030	545	36
30Amp TPN Socket	CSDBSTPN030	545	36



WiNtrip Metal Enclosures (with Din Rail) [HSN Code: 8537]			
For Mounting WiNtrip MCBs / RCCBs / Isolators			
Description	Product Code	MRP (₹)	MOQ
SP Enclosure	CSDBMCBESP	450	24
DP Enclosure	CSDBMCBEDP	450	24
TP Enclosure	CSDBMCBETP	525	12
FP Enclosure	CSDBMCBEFP	525	12



WiNtrip Plastic Enclosures without MCB [HSN Code: 8537]		
Description	Product Code	MRP (₹)
Plastic MCB Enclosure SP&DP/STD	CSDBMCBEPDP	175
Plastic MCB Enclosure TP&FP/STD	CSDBMCBEFPF	240

MCB Enclosure IP55 [HSN Code: 8537]			
4 Pole Enclosure			
Description	Product Code	MRP (₹)	MOQ
MCB Enclosure IP55 04 Way	CSDBEP04	1820	1

 non stockable items.

YOUR SAFETY MATTERS US

C&S Primo Plus Antibacterial Switches protects from Germs & Bacterial infections



ANTIBACTERIAL
MODULAR SWITCHES

MODULAR SWITCHES

WEATHER PROOF
ENCLOSURES

PrimoPlus SWITCHES

- Available with Anti Bacterial features*
Sleek design, compatible with PRIMO range of switches
- Highly aesthetic break free design
- Compatible to market boxes
- High gloss design
- Designed with front mounting and removable feature
- Ease of mounting
- Available in 1M -18M

DIVINO
S W I T C H E S

PrimoPlus
SWITCHES

COMBI
WEATHER-PROOF ENCLOSURES.

primo
S W I T C H E S



Modular Switches | DIVINO



CG20114PW



CG23114



CG20123PW



CG23123



CG20509PW



CG23509



CG20056PW



CG23056



CG20634PW



CG23634



CG20826PW



CG23826



CG20801PW



CG23801

Switches						
Product Code - Pure White / Grey	HSN Code	Description	Type	No. of Modules	MRP (₹)	MOQ
One-Way Switches						
CG20113PW / CG23113	85361010	1P-6A	General	1	107	20
CG20114PW / CG23114	85361010	1P-6A	Luminous	1	145	
CG20573PW / CG23573	85361020	1P-16A	General	1	167	
CG20574PW / CG23574	85361020	1P-16A	Luminous	1	192	
CG20117PW / CG23117	85361020	1P-25A	General	1	216	
CG20118PW / CG23118	85361020	1P-25A	Luminous	1	265	
CG20120PW / CG23120	85361020	2P-32A	Luminous	2	391	10
Two-Way Switches						
CG20123PW / CG23123	85361010	1P-6A	General	1	141	20
CG20578PW / CG23578	85361020	1P-16A	General	1	209	

Product Code - Pure White / Grey	HSN Code	Description	Type	No. of Modules	MRP (₹)	MOQ
Bell Push Switches						
CG20508PW / CG23508	85361010	1P-6A	Luminous	1	184	20
CG20509PW / CG23509	85361010	1P-6A	With Symbol	1	145	

Product Code - Pure White / Grey	HSN Code	Description	Type	No. of Modules	MRP (₹)	MOQ
Blanking Modules						
CG20056PW / CG23056	85381010	1 Gang	-	1	33	40
CG20073PW / CG23073	85381010	2 Gang	-	2	58	20

Product Code - Pure White / Grey	HSN Code	Description	Type	No. of Modules	MRP (₹)	MOQ
Neon Indicators						
CG20634PW / CG23634	85361010	Red Color	-	1	95	20

Product Code - Pure White / Grey	HSN Code	Description	Type	No. of Modules	MRP (₹)	MOQ
Fan Regulator						
CG20826PW / CG23826	85361010	5 Step (100W)	Rotary	2	442	10
CG20827PW / CG23827	85361010	4 Step (100W)	Rotary	1	351	20

Product Code - Pure White / Grey	HSN Code	Description	Type	No. of Modules	MRP (₹)	MOQ
Dimmer						
CG20801PW / CG23801	85361010	500W	Rotary (Stepless)	2	439	10
CG20804PW / CG23804	85361010	300W	Rotary (Stepless)	1	388	20



Modular Switches | DIVINO



CG20370PW CG23370

Socket						
Product Code - Pure White / Grey	HSN Code	Description	For Plug Pin	No. of Modules	MRP (₹)	MOQ
Sockets With Safety Shutters						
CG20370PW / CG23370	85361010	6A Socket 3 Pin (Flushed)	Round	2	137	10
CG20354PW / CG23354	85361020	6/16A Twin Socket 3 Pin (Flushed)	Round	3	264	6
CG20352PW / CG23352	85361020	6/16A Twin Socket 3 Pin (Projected)	Round	2	250	10



CG20251PW CG23251

Product Code - Pure White / Grey	HSN Code	Description	Nos. Pairs	For Plug Pin	No. of Modules	MRP (₹)	MOQ
Telephone / Computer / TV Socket							
CG20251PW / CG23251	85361010	RJ11	2	Twisted pair	1	115	20
CG20271PW / CG23271	85361010	RJ45 CAT5e	4	UTP		446	
CG20228PW / CG23228	85361010	TV Socket	-	-		109	
CG20272PW / CG23272	85361010	RJ45 CAT6	4	UTP		527	
CG20273PW / CG23273	85361010	RJ45 CAT6a		UTP		1158	



CG20275PW

USB Charger Socket					
Product Code - Pure White / Grey	HSN Code	Description	No. of Modules	MRP (₹)	MOQ
CG20275PW / CG23275	85044030	USB Charger Socket 2.1A (Fast Charging)	1	900	20



CG20815PW

Hospitality Range					
Product Code - Pure White / Grey	HSN Code	Description	No. of Modules	MRP (₹)	MOQ
Energy Key Tag					
CG20815PW / CG23815	85361020	1P-25A, 230V-Energy Key Switch With Tag	2	579	1
CG20434PW / CG23434	85361010	Tag For Energy Key Tag	-	119	-
Application activation of functions service inside hotel rooms (e.g.m light, air-conditioner, minibar) when the room is occupied (with badge inserted)					



CG20609PW CG23609

Do Not Disturb					
Product Code	HSN Code	Description	No. of Modules	MRP (₹)	MOQ
CG20609PW / CG23609	85361010	Indicator	1	105	20
CG20124PW / CG23124	85361010	6A-230V, IW, SP Luminous Switch		149	
CG20612PW / CG23612	85361010	Unit (Indicator+Switch)	1+1	249	10



CG20610PW CG23610

Room Occupied					
Product Code	HSN Code	Description	No. of Modules	MRP (₹)	MOQ
CG20610PW / CG23610	85361010	Indicator	1	105	20
CG20125PW / CG23125	85361010	6A-230V, IW, SP Luminous Switch		149	
CG20613PW / CG23613	85361010	Unit (Indicator+Switch)	1+1	249	10



CG20611PW CG23611

Make My Room					
Product Code	HSN Code	Description	No. of Modules	MRP (₹)	MOQ
CG20611PW / CG23611	85361010	Indicator	1	105	20
CG20126PW / CG23126	85361010	6A-230V, IW, SP Luminous Switch		149	
CG20614PW / CG23614	85361010	Unit (Indicator+Switch)	1+1	249	10



Modular Switches | DIVINO



CG20825PW



CG20632



CG20436PW



CG20443PW



CG26401PW



CG20362PW



CG25703PW



CG25803PW

Product Code - Pure White / Grey	HSN Code	Description	No. of Modules	MRP (₹)	MOQ
Time Delay Electronic Switch (Card Operated)					
CG20825PW / CG23825	85361020	25A	3	1300	6
Foot Lamp					
CG20631	94051090	230V-LED Yellow Night Lamp	3	361	6
CG20632	94051090	230V-LED Blue Night Lamp			
CG20633	94051090	230V-LED White Night Lamp			

Modular Miniature Case Circuit Breaker - Wintrip 'S'					
Product Code - Pure White	HSN Code	Description	No. of Modules	MRP (₹)	MOQ
Single Pole					
CG20431PW	85361010	6A Single Pole 4.5kA - Tripping Curve 'C'	1	210	12
CG20432PW	85361010	10A Single Pole 4.5kA - Tripping Curve 'C'			
CG20433PW	85361020	16A Single Pole 4.5kA - Tripping Curve 'C'			
CG20437PW	85361020	20A Single Pole 4.5kA - Tripping Curve 'C'			
CG20435PW	85361020	25A Single Pole 4.5kA - Tripping Curve 'C'			
CG20436PW	85361020	32A Single Pole 4.5kA - Tripping Curve 'C'			
Double Pole					
CG20438PW	85361010	6A Double Pole 4.5kA - Tripping Curve 'C'	2	503	6
CG20439PW	85361010	10A Double Pole 4.5kA - Tripping Curve 'C'			
CG20440PW	85361020	16A Double Pole 4.5kA - Tripping Curve 'C'			
CG20441PW	85361020	20A Double Pole 4.5kA - Tripping Curve 'C'			
CG20442PW	85361020	25A Double Pole 4.5kA - Tripping Curve 'C'			
CG20443PW	85361020	32A Double Pole 4.5kA - Tripping Curve 'C'			

Power Unit				
Product Code - Pure White	HSN Code	Description	MRP (₹)	MOQ
CG26401PW	85371000	16Amp Power Unit	922	1
Power Unit with PVC				
CG26404PW	85371000	16Amp Power Unit	803	1

Motor Starter					
Product Code - Pure White / Grey	HSN Code	Description	No. of Modules	MRP (₹)	MOQ
CG20362PW / CG23362	85361020	Motor Starter 16A	2	430	1
CG20364PW / CG23364	85361020	Motor Starter 25A	2	548	

Pure White Cover Plates With Support Plate				
Product Code - Vera / Virna	HSN Code	Description	MRP (₹)	MOQ
CG25701PW / CG25801PW	85381010	1 Module Plate	124	10
CG25702PW / CG25802PW	85381010	2 Module Plate		
CG25703PW / CG25803PW	85381010	3 Module Plate		
CG25704PW / CG25804PW	85381010	4 Module Plate	197	5
CG25706PW / CG25806PW	85381010	6 Module Plate	264	
CG25708PW / CG25808PW	85381010	8 Module Plate - Vertical	341	
CG25709PW / CG25809PW	85381010	8 Module Plate - Horizontal		
CG25712PW / CG25812PW	85381010	12 Module Plate	428	
CG25718PW / CG25818PW	85381010	18 Module Plate	649	



Modular Switches | DIVINO



CG25803GR

Glossy Grey Cover Plates With Support Plate				
Product Code - Vera / Virna	HSN Code	Description	MRP (₹)	MOQ
CG25701GR / CG25801GR	85381010	1 Module Plate	178	10
CG25702GR / CG25802GR	85381010	2 Module Plate		
CG25703GR / CG25803GR	85381010	3 Module Plate		
CG25704GR / CG25804GR	85381010	4 Module Plate	261	5
CG25706GR / CG25806GR	85381010	6 Module Plate	328	
CG25708GR / CG25808GR	85381010	8 Module Plate - Vertical	383	
CG25709GR / CG25809GR	85381010	8 Module Plate - Horizontal		
CG25712GR / CG25812GR	85381010	12 Module Top Plate	507	
CG25718GR / CG25818GR	85381010	18 Module Plate	800	



CG25803BG

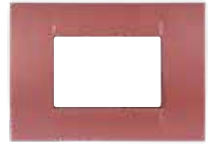

CG25803COR

Cover Plates With Support Plate				
Product Code - Vera / Virna	HSN Code	Description	MRP (₹)	MOQ
Cadet Grey / Black Olive / Argent Grey / Charcol Black / Arsenic Black / Champagne / Candy Red / Corel Red / British Green Plates				
CG25701 / CG25801	85381010	1 Module Plate	267	10
CG25702 / CG25802	85381010	2 Module Plate		
CG25703 / CG25803	85381010	3 Module Plate		
CG25704 / CG25804	85381010	4 Module Plate	398	5
CG25706 / CG25806	85381010	6 Module Plate	549	
CG25708 / CG25808	85381010	8 Module - Vertical	592	
CG25709 / CG25809	85381010	8 Module - Horizontal		
CG25712 / CG25812	85381010	12 Module Plate	755	
CG25718 / CG25818	85381010	18 Module Plate	986	

Please add codes CG for Cadet Grey, BO for Black Olive, AG for Argent Grey, CB for Charcol Black, AB for Arsenic Black, CH for Champagne, CAR for Candy Red, COR for Corel Red, BG for British Green Plates e.g. for ordering one module Vera Cadet Grey plate code would be CG25701CG



CG25703BW



CG25803EW

English Walnut & Burly Wood Cover Plates With Support Plate				
Product Code Vera / Virna	HSN Code	Description	MRP (₹)	MOQ
CG25701 / CG25801	85381010	1 Module Plate	334	10
CG25702 / CG25802	85381010	2 Module Plate		
CG25703 / CG25803	85381010	3 Module Plate		
CG25704 / CG25804	85381010	4 Module Plate	522	5
CG25706 / CG25806	85381010	6 Module Plate	721	
CG25708 / CG25808	85381010	8 Module Plate - Vertical	743	
CG25709 / CG25809	85381010	8 Module Plate - Horizontal		
CG25712 / CG25812	85381010	12 Module Top Plate	970	
CG25718 / CG25818	85381010	18 Module Plate	1104	

Please add codes EW for English Walnut and BW for Burly Wood e.g. for ordering one module Vera English Walnut plate code would be CG25701EW

Divino Cover Plate Sizes (All dimensions in mm)

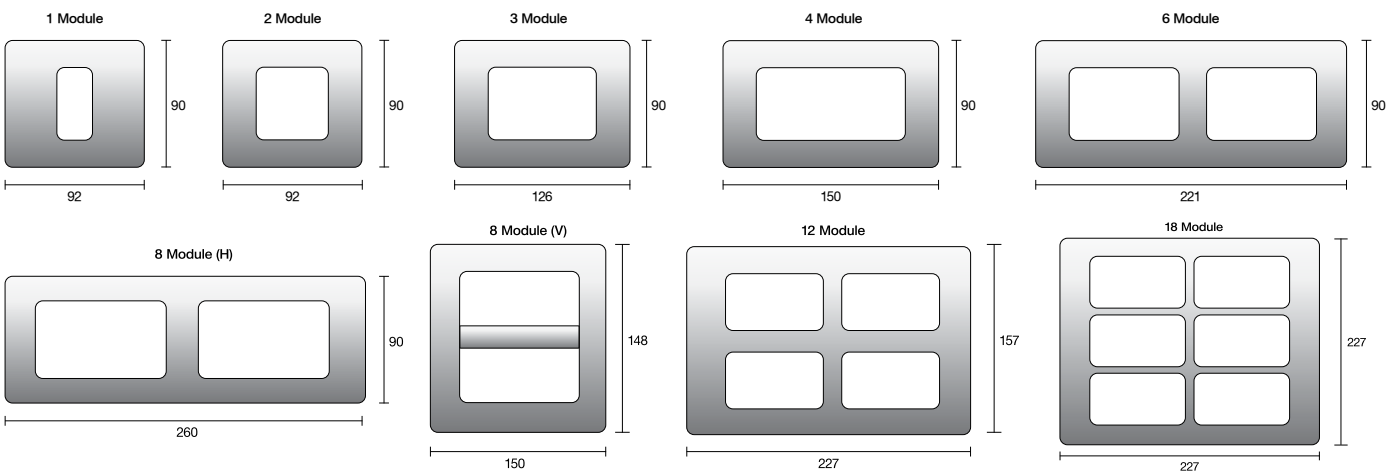



Weather Proof Enclosures COMBI



CG26000W CG26400W



CG24025W CG26018W



CG26012W

IP55 & IP40 Enclosures						
Product Code	HSN Code	Description	Configuration	MRP (₹)	MOQ	
Watertight And Dust Proof Enclosures IP55-Surface Mounting						
CG26000W	85371000	Bell Push	1 Module	642	1	
CG26400W	85371000	16A Switch, 6/16A Socket	3 Module	1093		
CG26016W	85371000	6A Switch	1 Module	593		
IP55 Motor Starter						
CG26018W	85381010	IP55 2M Enclosure With 16A Motor Starter		1069	1	
CG26019W	85381010	IP55 2M Enclosure With 25A Motor Starter		1256		
Watertight Plates For Flush Mounting Installations IP55 (Compatible with 3M concealed box)						
CG24025W	85381010	3 Gang		680	10	
Product Code	HSN Code	Description	Configuration	External Dim. LxHxD (mm)	MRP (₹)	MOQ
Watertight Enclosures For Fixed Or Movable Applications						
CG26010W	85381010	1 Gang	Module 1	80x64x59	459	10
CG26011W	85381010	2 Gang	Module 2	80x64x59	476	
CG26012W	85381010	3 Gang	Module 3	80x96x59	575	
CG26013W	85381010	4 Gang	Module 4x1	80x128x59	754	
CG26014W	85381010	8 Gang	Module 4x2	160x128x59	1286	5
CG26015W	85381010	12 Gang	Module 4x3	240x128x59	1695	3

COMBI WEATHER PROOF ENCLOSURES



DUST PROOF
WATER PROOF

A Switch designed to win the biggest test.
Nature...



CG28015

Top Plug				
Product Code	HSN Code	Description	MRP (₹)	MOQ
CG28014	85361010	6A Plug Top	65	10
CG28015	85361020	16A Plug Top	93	



CG28017

Top Plug with Indicator				
Product Code	HSN Code	Description	MRP (₹)	MOQ
CG28017	85361010	16A Plug Top	104	10



CG28020

Multi Plug Socket				
Product Code	HSN Code	Description	MRP (₹)	MOQ
CG28020	85361020	6A Multi Plug Socket	88	20



ACBHS001 ACBHA004



ACBHA005



ACBHS006



ACBHS008

Batten Holder				
Product Code	HSN Code	Description	MRP (₹)	MOQ
ACBHS001	85381010	Straight Batten Holder (Plain)	54	20
ACBHA003	85381010	Angular Batten Holder (Plain)		
ACBHS002	85381010	Straight Batten Holder (Fancy)	65	
ACBHA004	85381010	Angular Batten Holder (Fancy)		
ACBHA005	85381010	Batten Holder common (2 in 1)	75	
ACBHS006	85381010	Square Batten Holder (Plain)	86	
ACBHA007	85381010	Square angle Batten Holder (Plain)		
ACBHS008	85381010	Slim Batten Holder (Fancy)	94	
ACBHA009	85381010	Slim angle Batten Holder (Fancy)		
Ceiling Rose				
ACCR001	85381010	Ceiling rose	45	20



ACCR001

Surface Plastic Box				
Product Code	HSN Code	Description	MRP (₹)	MOQ
ACSMB001	85381010	1 Module	68	10
ACSMB001	85381010	2 Module	68	
ACSMB003	85381010	3 Module	88	
ACSMB004	85381010	4 Module	95	
ACSMB006	85381010	6 Module	128	
ACSMB008	85381010	8 Module (Horizontal)	176	
ACSMB009	85381010	8 Module (Vertical)	176	5
ACSMB012	85381010	12 Module	223	
ACSMB018	85381010	18 Module	250	

A Piece of **Art** with Complete **Safety, Comfort & Aesthetics** for your **Walls**

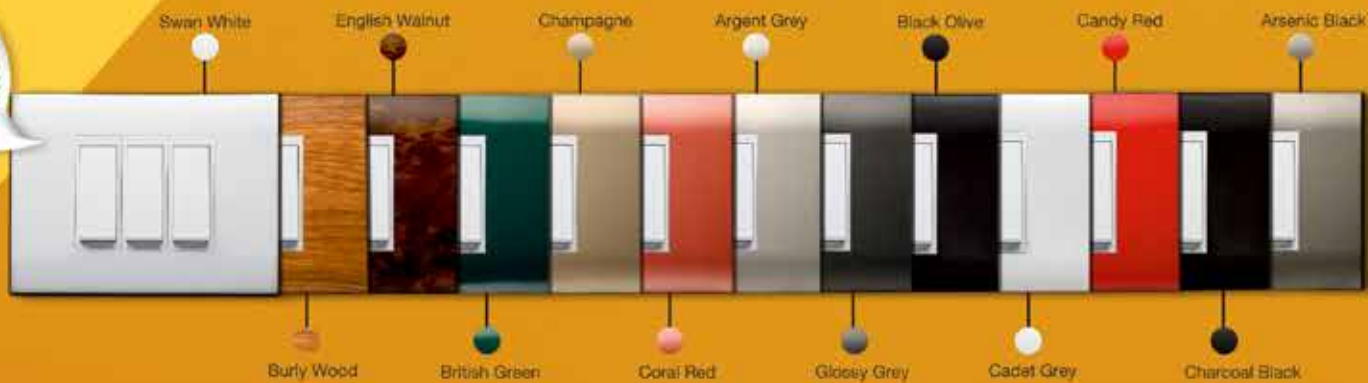
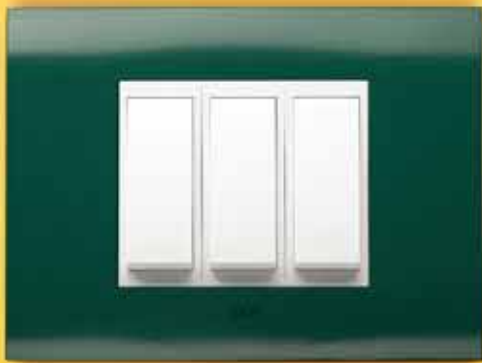

- Available with 1 Module to 18 Module*
- Sleek Design and Compatible with Primo Range of Switches.
- Highly Aesthetic Break Free Design.
- Compatible to Market Boxes
- Designed with Front Mount & Removal Option
- Ease of Mounting

* The Antibacterial feature are available only in White & Grey top plates & accessories.



CS20114P



CS20123P

Switches							
Product Code - Pure White / Grey	HSN Code	Description	Type	No. Modules	MRP (₹)	MOQ	
One-Way Switches							
CS20113P / CS23113P	85361010	6A, 250V	General	1	94	20	
CS20114P / CS23114P	85361010	6A, 250V	Luminous	1	118		
CS20115P / CS23115P	85361010	6A, 250V	Luminous	2	131	10	
CS20573P / CS23573P	85361020	16A, 250V	General	1	137	20	
CS20574P / CS23574P	85361020	16A, 250V	Luminous	1	172		
CS20575P / CS23575P	85361020	16A, 250V	Luminous	2	180	10	
CS20117P / CS23117P	85361020	25A, 250V	General	1	181	20	
CS20118P / CS23118P	85361020	25A, 250V	Luminous	1	214		
CS20119P / CS23119P	85361020	25A, 250V	General	2	216	10	
CS20120P / CS23120P	85361020	25A, 250V	Luminous	2	239		
Two-Way Switches							
CS20123P / CS23123P	85361010	6A, 250V	General	1	130	20	
CS20124P / CS23124P	85361010	6A, 250V	General	2	134	10	
CS20578P / CS23578P	85361020	16A, 250V	General	1	204	20	
CS20579P / CS23579P	85361020	16A, 250V	General	2	225	10	



CS20511P



CS20056P

Product Code - Pure White / Grey	HSN Code	Description	Type	No. Modules	MRP (₹)	MOQ	
Bell Push Switches							
CS20509P / CS23509P	85361010	6A, Bell Push	General	1	126	20	
CS20508P / CS23508P	85361010	6A, Bell Push	Luminous	1	146		
CS20510P / CS23510P	85361010	6A, Bell Push	General	2	140	10	
CS20511P / CS23511P	85361010	6A, Bell Push	Luminous	2	147		
Blanking Module							
CS20056P / CS23056P	85381010	1M Blank	General	1	32	50	



CS20631

Product Code - Pure White / Grey	HSN Code	Description	No. Modules	MRP (₹)	MOQ	
Neon Indicator						
CS20631P / CS23631P	85361010	Neon Indicator Red	1	75	20	



CS20801P

Product Code - Pure White / Grey	HSN Code	Description	No. Modules	MRP (₹)	MOQ	
Fan Regulator / Dimmer						
CS20826P / CS23826P	85361010	5-Step Fan Regulator 100W	2	417	10	
CS20827P / CS23827P	85361010	4-Step Fan Regulator 100W	1	335	20	
CS20801P / CS23801P	85361010	Rotary Type Dimmer 500W	2	425	10	
CS20804P / CS23804P	85361010	Rotary Type Dimmer 300W	1	311	20	



CS20354P CS20370P

Product Code - Pure White / Grey	HSN Code	Description	No. Modules	MRP (₹)	MOQ
Sockets with Safety Shutters					
CS20370P / CS23370P	85361010	6A, 3 Pin	2	111	10
CS20352P / CS23352P	85361020	6/16A, 6 Pin	3	205	
CS20354P / CS23354P	85361020	6/16A, Socket Projected	2	193	



CS20228P

Product Code - Pure White / Grey	HSN Code	Description	No. Modules	MRP (₹)	MOQ
TV Socket / Flex Outlet					
CS20228P / CS23228P	85361010	TV Socket	1	105	20
CS20237P / CS23237P	85361010	Flex Outlet	1	73	



CS20251P

Product Code - Pure White / Grey	HSN Code	Description	No. Modules	MRP (₹)	MOQ
Telephone / Computer Socket					
CS20251P / CS23251P	85361010	RJ 11, Telephone Jack	1	105	20
CS20271P / CS23271P	85361010	RJ 45, Computer Jack CAT5e	1	332	
CS20272P / CS23272P	85361010	RJ 45, Computer Jack CAT6	1	515	
CS20273P / CS23273P	85361010	RJ 45, Computer Jack CAT6a	1	986	



CS20275P

USB Charger Socket					
Product Code - Pure White / Grey	HSN Code	Description	No. of Modules	MRP (₹)	MOQ
CS20275P / CS23275P	85044030	USB Charger Socket 2.1A (Fast Charging)	1	890	20



CS20816P

Hospitality Range					
Product Code - Pure White / Grey	HSN Code	Description	No. of Modules	MRP (₹)	MOQ
Energy Saving Switch					
CS20816P / CS23816P	85361020	25A, Energy Saving Switch With Key Tag & Indicator	2	473	1
APPLICATION: activation of functions and service inside hotel rooms (e.g. light, air-conditioner, minibar) when the room is occupied (with badge inserted).					



CS20610P CS20611P

Product Code - Pure White / Grey	HSN Code	Description	No. of Modules	MRP (₹)	MOQ
DND MMR Switches					
CS20610P / CS23610P	85361010	DND/MMR External Indicator Unit	1	224	20
CS20611P / CS23611P	85361010	DND/MMR Internal Switch Unit	1+1	217	10



CS20633P CS20632P

Skirt Light / Night Lamp					
Product Code - Pure White / Grey	HSN Code	Description	No. of Modules	MRP (₹)	MOQ
CS20632P / CS23632P	94051090	Skirt light 2M	2	354	10
CS20633P / CS23633P	94051090	Night Lamp 2M	2	371	10



CS26404PW

Primo Plus Power Unit with PVC					
Product Code - Pure White	HSN Code	Description	No. of Modules	MRP (₹)	MOQ
CS26404PW	85371000	Power Unit Combo 16A MCB Protected Socket	4	758	1



CS25803WH

Product Code	HSN Code	Description	MRP (₹)	MOQ
Swan White (Cover Plates with Support Plate)				
CS25801WH	85381010	1 Module Plate	90	10
CS25802WH	85381010	2 Module Plate		
CS25803WH	85381010	3 Module Plate	125	
CS25804WH	85381010	4 Module Plate	131	
CS25806WH	85381010	6 Module Plate	191	
CS25808WH	85381010	8 Module Plate (Horizontal)	239	
CS25809WH	85381010	8 Module Plate (Vertical)		
CS25812WH	85381010	12 Module Plate	322	5
CS25816WH	85381010	16 Module Plate	373	
CS25818WH	85381010	18 Module Plate	395	



CS25803GR

Glossy Grey (Cover Plates with Support Plate)				
CS25801GR	85381010	1 Module Plate	101	10
CS25802GR	85381010	2 Module Plate		
CS25803GR	85381010	3 Module Plate	130	
CS25804GR	85381010	4 Module Plate	145	
CS25806GR	85381010	6 Module Plate	208	
CS25808GR	85381010	8 Module Plate (Horizontal)	265	
CS25809GR	85381010	8 Module Plate (Vertical)		
CS25812GR	85381010	12 Module Plate	350	5
CS25816GR	85381010	16 Module Plate	432	
CS25818GR	85381010	18 Module Plate	460	



Cover Plates with Support Plate				
Product Code	HSN Code	Description	MRP (₹)	MOQ
Cadet Grey / Black Olive / Argent Grey / Charcol Black / Arsenic Black / Champagne / Candy Red / Corel Red / British Green Plates				
CS25801	85381010	1 Module Plate	197	10
CS25802	85381010	2 Module Plate		
CS25803	85381010	3 Module Plate	233	
CS25804	85381010	4 Module Plate	261	
CS25806	85381010	6 Module Plate	394	5
CS25808	85381010	8 Module - Horizontal	441	
CS25809	85381010	8 Module - Vertical		
CS25812	85381010	12 Module Plate	571	
CS25816	85381010	16 Module Plate	610	
CS25818	85381010	18 Module Plate	739	
Please add codes CS for Cadet Grey, BO for Black Olive, AG for Argent Grey, CB for Charcol Black, AB for Arsenic Black, CH for Champagne, CAR for Candy Red, COR for Corel Red, BG for British Green Plates e.g. for ordering one module Cadet Grey plate code would be CS25801				



CS25803BW



CS25803EW

English Walnut & Burly Wood Cover Plates with Support Plate				
Product Code	HSN Code	Description	MRP (₹)	MOQ
CS25801	85381010	1 Module Plate	258	10
CS25802	85381010	2 Module Plate		
CS25803	85381010	3 Module Plate		
CS25804	85381010	4 Module Plate		
CS25806	85381010	6 Module Plate	508	5
CS25808	85381010	8 Module Plate - Horizontal		
CS25809	85381010	8 Module Plate - Vertical		
CS25812	85381010	12 Module Top Plate	759	
CS25816	85381010	16 Module Top Plate	847	
CS25818	85381010	18 Module Plate	901	

Please add codes EW for English Walnut and BW for Burly Wood e.g. for ordering one module English Walnut plate code would be CS25801EW

Primo Plus Cover Plate Sizes (All dimensions in mm)

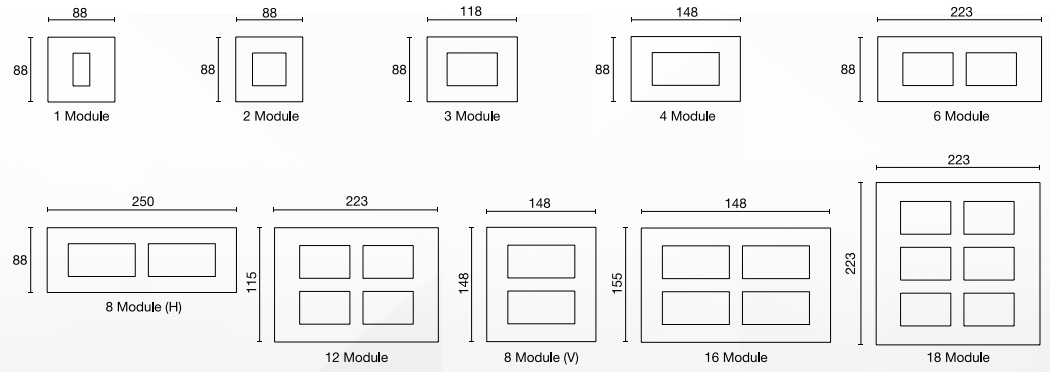

A Piece of **Art**
for your **Walls**



- 
FRONT MOUNT & REMOVAL OPTION
- 
SLEEK DESIGN
- 
UNBREAKABLE DESIGN
- 
SMOOTH TO TOUCH
- 
ANTIBACTERIAL PROTECTION
- 
OPERATION
- 
WARRANTY



Modular Switches | PRIMO



CS20114



CS20123



CS20511



CS20056



CS20631



CS20801



CS20370



CS20228



CS20251

Switches						
Product Code - Pure White	HSN Code	Description	Type	No. Modules	MRP (₹)	MOQ
One-Way Switches						
CS20113	85361010	6A, 250V	General	1	80	20
CS20114	85361010	6A, 250V	Luminous	1	109	
CS20115	85361010	6A, 250V	Luminous	2	121	10
CS20573	85361020	16A, 250V	General	1	127	20
CS20574	85361020	16A, 250V	Luminous	1	157	
CS20575	85361020	16A, 250V	Luminous	2	167	10
CS20117	85361020	25A, 250V	General	1	168	20
CS20118	85361020	25A, 250V	Luminous	1	199	
CS20119	85361020	25A, 250V	General	2	199	10
CS20120	85361020	25A, 250V	Luminous	2	222	
Two-Way Switches						
CS20123	85361010	6A, 250V	General	1	123	20
CS20124	85361010	6A, 250V	General	2	127	10
CS20578	85361020	16A, 250V	General	1	176	20
CS20579	85361020	16A, 250V	General	2	180	10

Product Code - Pure White	HSN Code	Description	Type	No. Modules	MRP (₹)	MOQ
Bell Push Switches						
CS20509	85361010	6A, Bell Push	General	1	105	20
CS20508	85361010	6A, Bell Push	Luminous	1	122	
CS20510	85361010	6A, Bell Push	General	2	130	10
CS20511	85361010	6A, Bell Push	Luminous	2	137	
Blanking Module						
CS20056	85381010	1M Blank	General	1	28	50

Product Code - Pure White	HSN Code	Description	No. Modules	MRP (₹)	MOQ
Neon Indicator					
CS20631	85361010	Neon Indicator Red	1	70	20

Product Code - Pure White	HSN Code	Description	No. Modules	MRP (₹)	MOQ
Fan Regulator / Dimmer					
CS20826	85361010	5-Step Fan Regulator 100W	2	405	10
CS20827	85361010	4-Step Fan Regulator 100W	1	314	20
CS20801	85361010	Rotary Type Dimmer 500W	2	390	10
CS20804	85361010	Rotary Type Dimmer 300W	1	295	20
Sockets with Safety Shutters					
CS20370	85361010	6A, 3 Pin	2	100	10
CS20352	85361020	6/16A, 6 Pin	3	198	
CS20354	85361020	6/16A, Socket Projected	2	184	

Product Code - Pure White	HSN Code	Description	No. Modules	MRP (₹)	MOQ
TV Socket / Flex Outlet					
CS20228	85361010	TV Socket	1	98	20
CS20237	85361010	Flex Outlet	1	62	

Product Code - Pure White	HSN Code	Description	No. Modules	MRP (₹)	MOQ
Telephone / Computer Socket					
CS20251	85361010	RJ 11, Telephone Jack	1	98	20
CS20271	85361010	RJ 45, Computer Jack CAT5e	1	316	
CS20272	85361010	RJ 45, Computer Jack CAT6	1	489	
CS20273	85361010	RJ 45, Computer Jack CAT6a	1	938	



Modular Switches | PRIMO



CS20275

USB Charger Socket					
Product Code - Pure White	HSN Code	Description	No. of Modules	MRP (₹)	MOQ
CS20275	85044030	USB Charger Socket 2.1A (Fast Charging)	1	875	20



CS20815

Hospitality Range					
Product Code - Pure White	HSN Code	Description	No. of Modules	MRP (₹)	MOQ
Energy Saving Switch					
CS20815	85361020	25A, Energy Saving Switch With Key Tag & Indicator	2	457	1
APPLICATION: activation of functions and service inside hotel rooms (e.g. light, air-conditioner, minibar) when the room is occupied (with badge inserted).					



CS20610

CS20611

Product Code - Pure White / Grey	HSN Code	Description	No. of Modules	MRP (₹)	MOQ
DND/MMR Switches					
CS20610	85361010	DND/MMR External Indicator Unit	1	210	20
CS20611	85361010	DND/MMR Internal Switch Unit	1+1	200	10



CS20633

CS20632

Skirt Light / Night Lamp					
CS20632	94051090	Skirt light 2M	2	341	10
CS20633	94051090	Night Lamp 2M	2	357	10



CS20431

CS20443

Modular Miniature Case Circuit Breaker - WiNtrip 'S'					
Product Code - Pure White	HSN Code	Description	No. of Modules	MRP (₹)	MOQ
Single & Double Pole					
CS20431	85361010	6A Single Pole 4.5kA - Tripping Curve 'C'	1	210	12
CS20432	85361010	10A Single Pole 4.5kA - Tripping Curve 'C'			
CS20433	85361020	16A Single Pole 4.5kA - Tripping Curve 'C'			
CS20437	85361020	20A Single Pole 4.5kA - Tripping Curve 'C'			
CS20435	85361020	25A Single Pole 4.5kA - Tripping Curve 'C'			
CS20436	85361020	32A Single Pole 4.5kA - Tripping Curve 'C'			
CS20438	85361010	6A Double Pole 4.5kA - Tripping Curve 'C'	2	503	6
CS20439	85361010	10A Double Pole 4.5kA - Tripping Curve 'C'			
CS20440	85361020	16A Double Pole 4.5kA - Tripping Curve 'C'			
CS20441	85361020	20A Double Pole 4.5kA - Tripping Curve 'C'			
CS20442	85361020	25A Double Pole 4.5kA - Tripping Curve 'C'			
CS20443	85361020	32A Double Pole 4.5kA - Tripping Curve 'C'			



CS26401W

Power Unit					
Product Code - Pure White	HSN Code	Description	No. of Modules	MRP (₹)	MOQ
CS26401W	85371000	Power Unit Combo 16A MCB Protected Socket	4	759	1



Modular Switches | PRIMO

Top Plates with Support Plate				
Product Code-Pure White	HSN Code	Description	MRP (₹)	MOQ
CS25701WH	85381010	1 Module Plate	78	10
CS25702WH	85381010	2 Module Plate		
CS25703WH	85381010	3 Module Plate	121	
CS25704WH	85381010	4 Module Plate	126	
CS25705WH	85381010	5 Module Plate (Compatible with 4M Metal Box)		
CS25706WH	85381010	6 Module Plate	171	
CS25707WH	85381010	8 Module-Horizontal	226	5
CS25709WH	85381010	8 Module Plate Horizontal (Compatible with 6M Metal Box)		
CS25710WH	85381010	10 Module-Vertical (Compatible With 8M (4+4) Metal Box)		
CS25711WH	85381010	10 Module-Horizontal (Compatible With 8M (H) Metal Box)	284	
CS25712WH	85381010	12 Module Plate		
CS25716WH	85381010	16 Module Plate (Compatible With 12M Metal Box)	360	
CS25718WH	85381010	18 Module Plate	370	
Red / Yellow/ Green/ Blue / Grey Plates				
CS25701	85381010	1 Module Plate	93	10
CS25702	85381010	2 Module Plate		
CS25703	85381010	3 Module Plate	136	
CS25704	85381010	4 Module Plate	141	
CS25705	85381010	5 Module Plate (Compatible With 4M Metal Box)		
CS25706	85381010	6 Module Plate	191	
CS25707	85381010	8 Module Horizontal	245	5
CS25709	85381010	8 Module Plate Horizontal (Compatible with 6M Metal Box)		
CS25710	85381010	10 Module-Vertical (Compatible With 8M (4+4) Metal Box)		
CS25711	85381010	10 Module-Horizontal (Compatible With 8M (H) Metal Box)	328	
CS25712	85381010	12 Module Plate		
CS25716	85381010	16 Module Plate (Compatible With 12M Metal Box)	399	
CS25718	85381010	18 Module Plate	458	
Please add following to codes for color selection GR for Grey / RD for RED / YL for Yellow / BL for Blue/ GN for Green e.g. for ordering one module red plate code would be CS25701RD				
Wooden				
CS25701WN	85381010	1 Module Plate	178	10
CS25702WN	85381010	2 Module Plate		
CS25703WN	85381010	3 Module Plate	226	
CS25704WN	85381010	4 Module Plate	245	
CS25705WN	85381010	5 Module Plate (Compatible With 4M Metal Box)		
CS25706WN	85381010	6 Module Plate	313	
CS25707WN	85381010	8 Module Horizontal	450	5
CS25709WN	85381010	10 Module-Vertical (Compatible With 8M (4+4) Metal Box)		
CS25710WN	85381010	10 Module-Vertical (Compatible With 8M (4+4) Metal Box)		
CS25711WN	85381010	10 Module-Horizontal (Compatible With 8M (H) Metal Box)	553	
CS25712WN	85381010	12 Module Plate		
CS25716WN	85381010	16 Module Plate (Compatible With 12M Metal Box)	586	
CS25718WN	85381010	18Module Plate	695	





WiNtrip 'S'

Single Lock Modular MCB

The perfect solution for AC's, Refrigerators & Electrical Appliances

- Safe || Convenient || Energy Saving || Wide Range || Compact Design || Overload & Short Circuit Protection || Rapid Closing Mechanism || Easy to Operate



WiNtrip 'S' Modular MCB									
Single pole - Tripping Curve 'C' 4.5KA					Double pole - Tripping Curve 'C' 4.5KA				
Product Code	HSN Code	Description	MRP (₹)	MOQ	Product Code	HSN Code	Description	MRP (₹)	MOQ
CG20431R	85361010	6A	210	12	CG20438R	85361010	6A	503	6
CG20432R	85361010	10A			CG20439R	85361010	10A		
CG20433R	85361020	16A			CG20440R	85361020	16A		
CG20437R	85361020	20A			CG20441R	85361020	20A		
CG20435R	85361020	25A			CG20442R	85361020	25A		
CG20436R	85361020	32A			CG20443R	85361020	32A		

Non-Modular Miniature Case Circuit Breaker - WiNtrip 'S'					
Product Code - Pure White	HSN Code	Description	No. of Modules	MRP (₹)	MOQ
Single Pole					
CS20431N	85361010	6A Single Pole 4.5kA-Tripping Curve 'C'	1	210	12
CS20432N	85361010	10A Single Pole 4.5kA-Tripping Curve 'C'			
CS20433N	85361020	16A Single Pole 4.5kA-Tripping Curve 'C'			
CS20437N	85361020	20A Single Pole 4.5kA-Tripping Curve 'C'			
CS20435N	85361020	25A Single Pole 4.5kA-Tripping Curve 'C'			
CS20436N	85361020	32A Single Pole 4.5kA-Tripping Curve 'C'			
Double Pole					
CS20438N	85361010	6A Double Pole 4.5kA-Tripping Curve 'C'	2	503	6
CS20439N	85361010	10A Double Pole 4.5kA-Tripping Curve 'C'			
CS20440N	85361020	16A Double Pole 4.5kA-Tripping Curve 'C'			
CS20441N	85361020	20A Double Pole 4.5kA-Tripping Curve 'C'			
CS20442N	85361020	25A Double Pole 4.5kA-Tripping Curve 'C'			
CS20443N	85361020	32A Double Pole 4.5kA-Tripping Curve 'C'			



CS20436N



CS20438N



Modular Switches | PRIMO



CG24272



Metal Boxes- Fabricated (Boxes for Divino, Primo Plus and Primo)					
Product Code	HSN Code	Description	Dimension LxHxD (mm)	MRP (₹)	MOQ
CG24271	85381010	1 Module Box	75 X 75 X 50	59	10
CG24271	85381010	2 Module Box	75 X 75 X 50		
CG24272	85381010	3 Module Box	100 X 75 X 50	85	
CG24273	85381010	4 Module Box	135 X 76 X 50	96	
CG24274	85381010	6 Module Box	210 X 75 X 50	135	5
CG24275	85381010	8 Module Box (4 +4)	134 X 140 X 52		
CG24276	85381010	8 Module Box (Horizontal)	232 X 79 X 52	192	
CG24277	85381010	12 Module Box	210 X 140 X 50		
CG24279	85381010	16 Module Box	210 X 140 X 60	271	
CG24278	85381010	18 Module Box	210 X 210 X 56		

* 10M Top Plate shall be fitted in 8M (4+4) Vertical Metal Box (i.e. CG 24 275)
 * 5M Top Plate Shall be fitted in 4M Metal Box (i.e. CG 24 273)
 * Deep Drawn Metal Boxes are available on request.

Primo Cover Plate Sizes (All dimensions in mm)

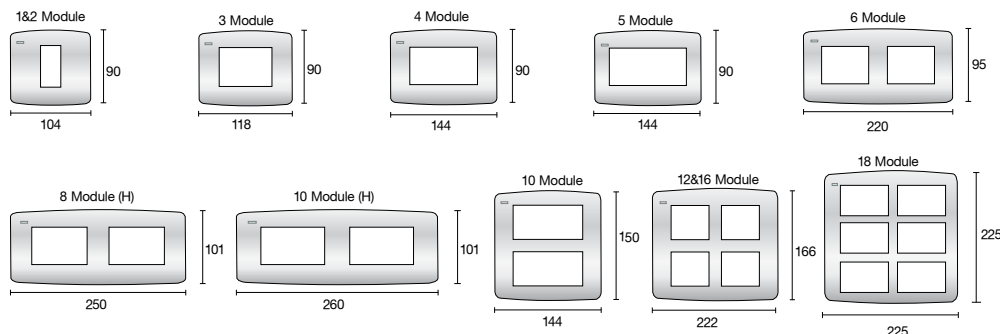

General Terms & Conditions

Price are subject to revision without prior notice and will be applicable as prevailing at the time of dispatch.

- This Pricelist supercedes all previous Price Lists.
- Maximum Retail Price (MRP) mentioned are maximum recommended selling prices inclusive of GST.
- All Prices are in Indian Rupees.

Warranty for Wiring Accessories

All our listed Electro-mechanical wiring devices carry a warranty, against manufacturing defects for a period of 10 years from the date of invoicing & 2 years for all mains related electronic wiring products viz. Dimmers, Step Fan regulator and Indicators subject to it's usages in normal recommended operating conditions. Guarantee does not include Metal boxes, Plug Tops and other stand alone products. The guarantee defines the company's entire liability & does not cover consequences loss or damage or reinstallations cost arising from defective product. The company liability shall be limited to exchange or repair of the product, at our discretion, provided that such defective products are returned to nearest Branch office.



DIVINO
SWITCHES

PrimoPlus
SWITCHES

PRIMO
SWITCHES

COMBI
WEATHER-PROOF ENCLOSURES.

Industrial Plugs & Sockets

Position of the Earthing Contact

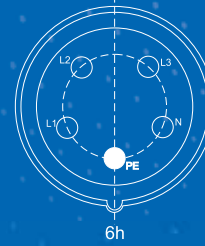

Position of the Earthing Contact

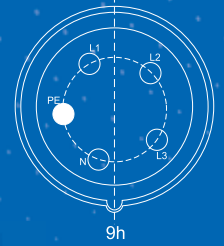

BENEFITS

- Safety through interchangeability
- High grade thermo plastic material assures:
 - Exceptional high impact resistance
 - High thermal stability
 - High insulated Quality
 - Good resistance to various chemicals
- Colour codes for easy identification of Plug & Sockets
- Locking device prevent unintended withdrawal



IEC 60309 Series

IP44 & IP67 Protection

Control & Signalling Devices

Metallic & Polycarbonate Series



Push Buttons & Pilot Lamps

- Ø22.5 mm Push Buttons, Emergency Stop PB, Selector switch
- Illuminated & Non Illuminated Actuators in Plastic & Metallic variants
- Pilot Lamps in LED / Filament / Neon types
- Push Button Stations 1/2/3/4 ways, IP65 / 166, NEMA-41/X protection
- High Mechanical and Electrical life
- Aesthetic and Elegant outlook
- Wide Range of colors | voltages available

Globally accepted





Industrial Plugs & Sockets

IEC 60309 Series

[HSN Code: 8536]

IP 44 & IP 67 Versions	DESCRIPTION	Rating (Amp)	Protection Degree	3 PIN, 2P+E 240V AC			4 PIN, 3P+E 415V AC			5 PIN, 3P+N+E 415V AC		
				Code	MRP (₹)	Reference h	Code	MRP (₹)	Reference h	Code	MRP (₹)	Reference h
	Panel Mounting Socket - Splash Proof	16	IP 44	CS62205	530	6	-	-	-	CS62210	890	6
		32		CS62216	920	6	-	-	-	CS62221	1030	6
	Panel Mounting Socket - Water Tight	16	IP 67	CS62227	1150	6	-	-	-	CS62232	1220	6
		32		CS62238	1230	6	-	-	-	CS62243	1620	6
		63		 CS63249	4540	6	-	-	-	CS63254	4170	6
		125		-	-	-	-	-	-	CS62262	15640	6
	Surface Mounting Socket - Splash Proof	16	IP 44	CS62404	880	6	-	-	-	CS62409	960	6
		32		CS62415	1090	6	-	-	-	CS62420	1160	6
	Surface Mounting Socket - Water Tight	16	IP 67	CS62426	1490	6	-	-	-	 CS62431	1940	6
		32		 CS62437	1860	6	 CS62283	2080	3	CS62442	2240	6
		63		 CS63448	5740	6	-	-	-	CS63453	5880	6
		125		-	-	-	-	-	-	 CS63463	20250	6
	Plugs - Splash Proof	16	IP 44	CS60004	460	6	-	-	-	CS60009	620	6
		32		CS60015	740	6	-	-	-	CS60020	890	6
	Plugs - Water Tight	16	IP 67	CS60026	990	6	-	-	-	CS60031	1300	6
		32		CS60037	1530	6	CS60145	1560	3	CS60042	1590	6
		63		 CS61048	4320	6	-	-	-	CS61053	4470	6
		125		-	-	-	-	-	-	CS60061	13260	6
	Surface Mounting Interlocked Switched Socket Outlet - Horizontal	16	IP 44	CS66004(H)	7000	6	-	-	-	 CS66109(H)	8930	6
		32		 CS66015(H)	8340	6	-	-	-	 CS66020(H)	9980	6
	Surface Mounting Interlocked Switched Socket Outlet - Vertical	16	IP 67	CS66200	7670	6	-	-	-	 CS66202	10870	6
		32		 CS66201	10720	6	-	-	-	 CS66203	12960	6
	Connector - Splash Proof	16	IP 44	CS62004	670	6	-	-	-	 CS66215	770	-
		32		CS62015	850	6	-	-	-	CS66225	1080	-
	Connector Water Tight	32	IP 67	-	-	-	CS62128	2080	3	-	-	-

Note: Plugs & Sockets 3 PIN, 2P+E 240V AC are in Blue color, 5 PIN, 3P+N+E 415V AC are in Red color

[HSN Code: 8536]

AC Distribution Box with Socket	DESCRIPTION	Rating (Amp)	Protection Degree	Code	MRP (₹)	Reference h
	AC Distribution Box (Includes Socket & Plug)	16A 3P 240V	IP 40	CS60045	1690	6
		32A 3P 240V		CS60046	2080	6
		32A 5P 415V		CS60047	3130	6
		63A 5P 415V		CS60048	8150	6

 non stockable items.



Control & Signalling Devices



Push Buttons: 22.5mm Without Contact Elements

Push Button Actuators with Carrier-Non-Illuminated [HSN Code: 8536]				
Description	Reference	MRP (₹)	MOQ	Product Picture
Push Spring Return Push Button	RCP2-BA1 ○	89	20	
	☒ RCP2-BA2 ●			
	RCP2-BA3 ●			
	RCP2-BA4 ●			
	RCP2-BA5 ●			
	☒ RCP2-BA6 ●			
Flush Spring Return Push Button with contact	☒ RCP2BA33 ●	216	10	
	RCP2BA35 ●			
Projecting Push Button	RCP2-BL1 ○	93	20	
	RCP2-BL2 ●			
	RCP2-BL3 ●			
	RCP2-BL4 ●			
	RCP2-BL5 ●			
	RCP2-BL6 ●			
Mushroom Head Push Button, Spring Return	RCP2-BC2 ●	136	8	
	RCP2-BC3 ●			
	☒ RCP2-BC4 ●			
	RCP2-BC5 ●			
	RCP2-BC6 ●			
	RCP2-BC6 ●			
Mushroom Head Push Button, Spring Return with contact	RCP2-BC21 ●	201	8	
	RCP2-BC31 ●			
	☒ RCP2-BC42 ●			
	RCP2-BC51 ●			
	RCP2-BC61 ●			
Mushroom Head ∅40mm Push Button Stay Put turn to release	RCP2BS54 ●	182	8	
Mushroom Head ∅40mm Push to Stay Pull to release	RCP2BT4 ●			
Mushroom Head ∅60mm Push Button Stay Put turn to release	RCP2BS64 ●	269	5	
Mushroom Head Push Button, Push to Stay & Key to release	RCP2BS14 ●	374	8	
Push Button Stay Put ∅30mm (Press to Lock turn to release)	RCP2BS44 ●	178	10	
Push Button Actuators with Carrier & Contact Element-Non-Illuminated [HSN Code: 8536]				
Flush Spring Return Push Button with 1NO Block	☒ RCP2-BA11 ○	145	10	
	☒ RCP2-BA21 ●			
	RCP2-BA31 ●			
	RCP2-BA51 ●			
	RCP2-BA61 ●			
	RCP2-BA41 ●			
Push Button with 1NC Block	RCP2-BA42 ●			
Projecting Head Push Button with 1NO Block	RCP2-BL11 ○	145	10	
	RCP2-BL21 ●			
	☒ RCP2-BL31 ●			
	RCP2-BL51 ●			
	RCP2-BL61 ●			
Projecting PB with 1NC Block	☒ RCP2-BL42 ●			
PB Actuators-Illuminated Flush w/o Series Resistor [HSN Code: 8536]				
Illuminated Actuator, Flush (With BA9 Filament Bulb) 12V, 24V, 48V, 110V AC / DC	RCP2-BW316▲○	216	10	
	RCP2-BW336▲●			
	RCP2-BW346▲●			
	RCP2-BW356▲●			
	RCP2-BW366▲●			
	RCP2-BW376▲○			
Illuminated Actuator, Flush (With BA9 Neon Bulb) 220V, 380V, 415V AC / DC	RCP2-BWN336▲●			
	RCP2-BWN346▲●			
	RCP2-BWN356▲●			

☒ non stockable items.

Push Button Actuators - Illuminated Flush with Series Resistor [HSN Code: 8536]

Description	Reference	MRP (₹)	MOQ	Product Picture
Illuminated Actuator, Flush (with BA9S Filament Bulb, 130V) 220V AC/DC	RCP2-BW317▲○	232	10	
	☒ RCP2-BW337▲●			
	☒ RCP2-BW347▲●			
	RCP2-BW357▲●			
	RCP2-BW367▲●			
	RCP2-BW377▲○			
	RCP2-BW387▲●			

LED Type Push Button Actuators - Illuminated Flush

Description	Reference	MRP (₹)	MOQ	Product Picture
Flush Illuminated with Integral Circuit LED 48V, 24V & 12V (AC/DC) also available in 110V AC, 110V DC, 240V AC, 220DC	RCP2-BWL317▲○	269	10	
	RCP2-BWL337▲●			
	☒ RCP2-BWL347▲●			
	☒ RCP2-BWL357▲●			
	☒ RCP2-BWL377▲○			
	RCP2-BWL387▲●			
	RCP2-BWL367▲●			
		479		

Push Button Actuator-Illuminated Projecting without Series Resistor

Description	Reference	MRP (₹)	MOQ	Product Picture
Illuminated Actuator, Flush (with BA9 filament bulb) 48V, 24V & 12V (AC/DC) also available in 110V AC, 110V DC, 240V AC, 220DC	RCP2-BW116▲○	207	10	
	RCP2-BW136▲●			
	RCP2-BW146▲●			
	RCP2-BW156▲●			
	RCP2-BW186▲●			
	RCP2-BW166▲●			
	RCP2-BW176▲○			
Illuminated Actuator, Flush (With BA9 Neon Bulb) 220V, 380V, 415V (AC/DC)	RCP2-BWN136▲●	POR		
	RCP2-BWN146▲●			
	RCP2-BWN156▲●			
	RCP2-BWN186▲●			

Push Button Actuator-Illuminated projecting without Series Resistor

Description	Reference	MRP (₹)	MOQ	Product Picture
Illuminated Actuator, Projecting (with BA9S Filament Bulb, 130V) 220V (AC/DC)	RCP2-BW117▲○	216	10	
	RCP2-BW137▲●			
	RCP2-BW147▲●			
	RCP2-BW157▲●			
	RCP2-BW187▲●			
	RCP2-BW167▲●			
	RCP2-BW177▲○			

LED Type Push Button Actuators - Illuminated Projecting Type of voltage AC/DC to be specified

Description	Reference	MRP (₹)	MOQ	Product Picture
Projecting Illuminated Actuator, with integral LED, suitable for operating 48V, 24V & 12V (AC/DC) also available in 110V AC, 110V DC, 240V AC, 220DC	RCP2-BWL117▲○	269	10	
	☒ RCP2-BWL137▲●			
	☒ RCP2-BWL147▲●			
	RCP2-BWL157▲●			
	RCP2-BWL177▲○			
	RCP2-BWL187▲●			
	RCP2-BWL167▲●			
		491		

Colour Code for Actuator / Lens

Colour Code	1	2	3	4	5	6	7	8
Colour of Actuator	White ○	Black ●	Green ●	Red ●	Yellow ●	Blue ●	-	-
Colour of Lens	White ○	-	Green ●	Red ●	Amber ●	Blue ●	Clear ○	Yellow ●







Control & Signalling Devices



Push Buttons: 22.5mm Without Contact Elements

Selector Switch Actuators with Carrier [HSN Code: 8536]				
Description	Reference	MRP (₹)	MOQ	Product Picture
2-Position Selector Switch (stay put)	RCP2-BD2	259	10	
3-Position Selector Switch, centre 'OFF' (stay put)	RCP2-BD3			
2-Position Selector Switch with extra long knob (stay put)	<input checked="" type="checkbox"/> RCP2-BJ2	259	10	
3-Position Selector Switch, with extra long knob centre 'OFF' (stay put)	RCP2-BJ3			
3-Position Selector Switch (Spring Return)	RCP2-BDR3	275	10	
3-Position Selector Switch extra long knob (Spring Return)	<input checked="" type="checkbox"/> RCP2-BJR3	275	10	
Selector Switch Actuators with Carrier & Contact Element				
2-Position Selector Switch (stay put) with 1NO Block	<input checked="" type="checkbox"/> RCP2-BD21	300	10	
2-Position Selector Switch, centre 'OFF' (stay put) with NO+NC Block	RCP2-BD25	367		
3-Position Selector Switch, centre 'OFF' (stay put) with NO+NC Block	RCP2-BD35			
Key Actuators with Carrier				
2-Position Key Switch, Key removable in unactuated position	<input checked="" type="checkbox"/> RCP2-BG2	374	10	
2-Position Key Switch, Key removable in both position	<input checked="" type="checkbox"/> RCP2-BG4			
2-Position Key Switch, Key removable in 'Right Hand' position	RCP2-BG02			
3-Position Key Switch, Key removable in centre 'OFF' position	<input checked="" type="checkbox"/> RCP2-BG3	389	10	
3-Position Key Switch, Key removable in all position	RCP2-BG0			
3-Position Key Switch, Key removable in 'Left Hand & Right Hand' position	RCP2-BG5			
3-Position Key Switch, Key removable in 'Left Hand' position	<input checked="" type="checkbox"/> RCP2-BG9			
3-Position Key Switch, Key removable in 'Right Hand' position	RCP2-BG7			
Push Buttons Extended Range				
Reset Extended Actuator Pushbutton - Round Type	<input checked="" type="checkbox"/> RCB2AL8R	84	24	
Reset Extended Actuator Pushbutton - Hex Type	<input checked="" type="checkbox"/> RCB2AL8H			
Plastic Adaptor for 30 mm hole to 22.5 mm.	<input checked="" type="checkbox"/> RP2-BZ41M	25	30	
Metal Adaptor for 30 mm hole to 22.5 mm	<input checked="" type="checkbox"/> RB2-BZ41M			
Recess (Guarded) Push button - Plastic	RP2-BA16 ○	74	20	
	RP2-BA26 ●			
	<input checked="" type="checkbox"/> RP2-BA36 ●			
	<input checked="" type="checkbox"/> RP2-BA46 ●			
	RP2-BA56 ●			
	RP2-BA66 ●			

non stockable items.

Push Buttons Extended Range [HSN Code: 8536]				
Description	Reference	MRP (₹)	MOQ	Product Picture
Intermittent Sounding Flashing Buzzer 15 ~ 20 mA, sound level 80 dB, 24V, 48V, 110V AC/DC 240V AC (* Add Voltage code)	<input checked="" type="checkbox"/> RB2-KS* ●	284	15	
Pilot Lamps with Series Resistor				
Pilot Lamp (with BA9S Filament Bulb 130V) 220V AC / DC	RCP2-BV71 ▲○	188	10	
	RCP2-BV73 ▲●			
	RCP2-BV74 ▲●			
	RCP2-BV75 ▲●			
	RCP2-BV76 ▲●			
	RCP2-BV77 ▲○			
Pilot Lamps with Series Resistor & Diode				
Pilot Lamp (with BA9S Filament Bulb 130V) 110V AC, 220V DC,	RCP2 BVD71 ▲○	204	10	
	RCP2-BVD73 ▲●			
	<input checked="" type="checkbox"/> RCP2-BVD74 ▲●			
	<input checked="" type="checkbox"/> RCP2-BVD75 ▲●			
	<input checked="" type="checkbox"/> RCP2-BVD76 ▲●			
	RCP2-BVD77 ▲○			
Contact Elements - NO/NC [HSN Code: 8536]				
Contact Element 1 NO	RP2- BE-101	85	50	
Contact Element 1 NC	RP2- BE-102			
LED Type Pilot Lamp Type of voltage AC / DC to be specified				
Pilot Light with integral circuit LED 48V, 24V & 12V (AC/DC) also available in 110V AC, 110V DC, 240V AC, 220DC	<input checked="" type="checkbox"/> RCP2-BVL73 ▲●	247	10	
	<input checked="" type="checkbox"/> RCP2-BVL74 ▲●			
	<input checked="" type="checkbox"/> RCP2-BVL75 ▲●			
	RCP2-BVL77 ▲○			
	RCP2-BVL71 ▲○			
	<input checked="" type="checkbox"/> RCP2-BVL78 ▲●			
	<input checked="" type="checkbox"/> RCP2-BVL76 ▲●	445		

How to Order:

Actuators, Contact Elements, Lens Assemblies can also be ordered separately or in combination, as required.

▲ Add Voltage Code

Non Stockable item

Motor Starters

- Industrial



- Conforms to IEC 60947-4-1
- 3Ø DOL Starter range: 0.5HP~60HP
- 3Ø Reversing DOL Starter range: 0.5HP~20HP
- 3Ø Star Delta Starter range: 7.5HP~350HP

Custom built Starter solutions with incomer MCCB & Electronic Motor Protection Relay

- 3Ø Intelligent Star Delta Starter range: 40HP~ 350HP
- 3Ø Intelligent Auto Transformer Starter range: 40HP~ 350HP



Motor Starters for Industrial Segment
Conforming IS/IEC60947-4-1



Std. Power Rating for 3Ph. Motor at 415V				Reference	Relay LR1D Range Amps	MRP (₹)	MOQ
HP	kW						
1.5	1.1			BE1-DXP204#307	1.6-2.5	3980	6
2.0	1.5			BE1-DXP204#308	2.5-4.0		
3	2.2			BE1-DXP204#310	4.0-6.0		
5	3.7			BE1-DXP204#312	5.5-8.0		
5.5	4.0			BE1-DXP204#314	7-10		
7.5	5.5			BE1-DXP204#316X	9-14		
12	9			BE1-DXP204#321	13-18	4500	6
15	11			BE1-DXP254#321XH	14-22	4715	
				BE1-DXP254#322	18-25		
25	18			BE1-DXP404#353	23-32	6810	



Std. Power Rating for 3Ph. Motor at 415V				Reference	Relay LR1D Range Amps	MRP (₹)	MOQ
HP	kW						
7.5	5.5			BE3-DXP204#312	5.5-8.0	14410	2
12	9			BE3-DXP204#314	7.0-10		
15	11			BE3-DXP204#316X	9-14		
20	15			BE3-DXP204#321	13-18	14610	
				BE3-DXP254#321XH	14-22	15970	
25	18			BE3-DXP254#322	18-25	18370	
30	22			BE3-DXP254#353	23-32	18370	

AC Coil Voltage Codes (Standard) for Heavy Duty Industrial Starter Type DX-P			
Industrial Starter	Voltage		
BE1-DXP	220	190-400#	250-450#
BE3-DXP	-	190-400#	250-450#
Coil Code	M	Q	N

Industrial Starters are available in the above wide band operating range Standard coil voltages.





Std. Power Rating for 3Ph. Motor at 415V				Reference	Relay Range Amps	MRP (₹)	MOQ
HP	kW						
0.5	0.37			LE1-D173#305	0.63-1.00	3525	1
0.75	0.55			LE1-D173#306	1.0-1.60		
1.5	1.1			LE1-D173#307	1.60-2.50		
2	1.5			LE1-D173#308	2.50 - 4.00		
3	2.2			LE1-D173#310	4.00 - 6.00		
5	3.7			LE1-D173#312	5.50 - 8.00		
7.5	5.5			LE1-D173#316X	9.0 - 14.0	7170	
12	9			LE1-D253#321	13.0 - 18.0		
15	11			LE1-D253#322	18.0 - 25.0		

























D Range Contactors & Overload Relays
Conforming IEC60947-1, IEC60947-4-1 & IEC60947-5-1





Control Relays 10 Amps		[HSN Code: 8536]	
Contact Configuration	A.C. Reference	MRP (₹)	MOQ
2NO+2NC	CA2DN1229 	1260	1
3NO+1NC	CA2DN1319 		
4NO	CA2DN140 		

■ Please specify Coil Voltage.

Power Contactors - 3 Pole, AC							[HSN Code: 8536]		
Size	AC1 Duty A	AC3 415V Long Life			Auxiliary Contacts		Reference	MRP (₹)	MOQ
		KW	HP	A					
Frame 1	25	4	5.5	9	1NO	-	LC1D093 	1190	1
					-	1NC	LC1D099 		
	25	5.5	7.5	12	1NO	-	LC1D123 	1380	
					-	1NC	LC1D129 		
	32	9	12.5	16	1NO	-	LC1D173 	1620	
					-	1NC	LC1D179 		
	32	11	15	22	1NO	-	LC1D223 	1870	
					-	1NC	LC1D229 		
Frame 2	40	11	15	25	1NO	-	LC1D253 	2110	
					-	1NC	LC1D259 		
Frame 2	50	15	20	32	1NO	-	LC1D323 	4310	
					-	1NC	 LC1D329 		
Frame 3	60	22	30	40	1NO	1NC	 LC1D403 	6370	
	80	25	35	50	1NO	1NC	 LC1D503 	7650	
	80	37	50	63	1NO	1NC	 LC1D633 	10790	
	125	45	60	80	1NO	1NC	 LC1D803 	13540	

 Non Stockable item
MOQ - Minimum Order Quantity

* Stock for accessories are subject to availability

Thermal Overload Relays Type LR1-Direct Mounting							[HSN Code: 8536]	
Relay Setting Range A	Std. Power Rating for 3 Phase Motor at 415V		Reference	MRP (₹)	Independent Mounting Kit	MOQ		
	HP	KW						
0.10~0.16	*	*	 LR1D09301	1580	Reference LA7-D0964 MRP ₹ 270 [HSN Code: 8538]	10		
0.16~0.25	*	*	 LR1D09302					
0.25~0.40	*	*	LR1D09303					
0.40~0.63	*	*	LR1D09304					
0.63~1.00	0.5	0.37	LR1D09305					
1.00~1.60	0.75	0.55	LR1D09306					
1.60~2.50	1.5	1.10	LR1D09307					
2.50~4.00	2.00	1.50	LR1D09308					
4.00~6.00	3.00	2.20	LR1D09310					
5.50~8.00	5.00	3.70	LR1D09312					
7.00~10.0	5.50	4.00	LR1D09314	1900	Reference LA7-D3264 MRP ₹ 390 [HSN Code: 8538]	10		
10.0~13.0	7.50	5.50	LR1D12316					
13.0~18.0	12.00	9.00	LR1D16321					
18.0~25.0	15.00	11.00	LR1D25322					
23.0~32.0	20.00	15.00	LR1D32353					
28.0~40.0	20.00	15.00	LR1D32355					
23.0~32.0	20.00	15.00	LR1D40353					
30.0~40.0	30.00	22.00	LR1D40355					
38.0~50.0	35.00	25.00	LR1D63357					
48.0~57.0	40.00	30.00	LR1D63359					
57.0~66.0	50.00	37.00	LR1D63361	5410	Reference LA7-D4054 MRP ₹ 520 [HSN Code: 8538]			

* There is no standard power rating for these motors. Select the overload relay in relation to the full load current.

AC Coil Voltage Codes for D Range Contactors (Standard)						
Contactor	Voltage					
	24	48	110*	220*	240*	415*
LC1-D	B	E	F	M	U	N

* Coils also available in wide band.

AC Coil Voltage Codes for D Range Contactors (Non-Standard)			
Contactor	Voltage		
	42	360	380
LC1-D	D	UW	Q

For Non-Standard Coil Voltage, please add ₹ 140/- in the list price.

Thermal OLR Type LR1-Independent Mounting					[HSN Code: 8536]
Relay Setting Range A	Std. Power Rating for 3 Phase Motor at 415V		Reference	MRP (₹)	MOQ
	HP	KW			
66.0 to 80.0	60	45	LR1-D80363	5380	1

Consisting of 1 NO+1 NC make before break contacts.



GLOBAL CERTIFICATION



Add-on-Blocks for D Range Contactors [HSN Code: 8538]					
Contactor		Reference	MRP (₹)	MOQ	
Additional Instantaneous Aux. Contact Blocks	Front Mounted	2 NO	LA1D20	390	20
		1 NO+1 NC	LA1D11		
		2 NC	LA1D02		
		4 NO	LA1D40		
	Front Mounted	3 NO+1 NC	LA1D31	580	
		2 NO+2 NC	LA1D22		
		1 NO+3 NC	LA1D13		
		4 NC	LA1D04		
Overlapping Aux. Contacts	Front Mounted	2 NO+2 NC	LA1D1111#	840	10

Spare AC Coil Voltage for D Range Contactors AC (Standard) [HSN Code: 8538]			
Use for Contactor AC (Standard)	Reference	MRP (₹)	MOQ
CA2-DN1	☒ LX1-D09	600	15
LC1-D09			
LC1-D12			
LC1-D17			
LC1-D25	☒ LX1-D25	710	10
LC1-D32			
LC1-D40	☒ LX1-D40	1770	10
LC1-D50**			
LC1-D63			
LC1-D80**			

■ Please specify Coil Voltage by indicating the Coil Voltage required.
 ** Spare Moulded Base for these Coils has Product code LA7-D40 and unit price is ₹ 190.

Definite Purpose Contactor
 Conforming IEC60947-1, IEC60947-4-1



Contactor [HSN Code: 8536]				
FLA	Resistive AMP Rating	Reference	MRP (₹)	MOQ
Single Pole (Without Shunt)				
25	30	☒ TCDP251	850	1
30	40	☒ TCDP301	895	
40	50	☒ TCDP401	940	
Single Pole (With Shunt)				
25	30	TCDP251S	875	1
30	40	TCDP301S	930	
40	50	TCDP401S	1010	
Two Pole				
20	30	TCDP202	960	1
30	40	TCDP302	965	
40	50	☒ TCDP402	1040	
Three Pole				
20	30	TCDP203	1155	1
30	40	TCDP303	1180	
40	50	☒ TCDP403	1335	

AC Coil Voltage Codes for Definite Purpose Contactors			
Voltage	24VAC	110VAC	240VAC
50Hz	B5	G5	U5
60Hz	B6	G6	U6

introducing...

WiNbreak - CSC Series

Adjustable Overload: 0.7~1.0 In■ $I_{cs}=100\% I_{cu}$ ■ $U_i=750V$ ■ $U_{imp}=8kV$ 

Salient Features

- Conforms to IS/IEC 60947-2
- Breaking Capacity: Upto 37kA @ 415 AC
- Range: 15A~250A, 2P
- Frame Size: 125AF & 250AF
- Positive Isolation
- Trip Free Mechanism
- Composed to User-Friendly Method
- Wide Range of installable accessories
- Internal & External Accessories can be commonly used in all WiNbreak-CSC MCCB
-

For further detail please contact nearest C&S Electric Branch Office

Standard packing includes, Insulating phase barriers and Hardwares



MCCBs

Winbreak MCCBs - CSC Series

- Conforms to IS/IEC 60947-2
- Ics=100%Icu
- Range: 15A -250A, 2 Pole
- Breaking capacity: 18kA, 26kA, 37kA
- Positive Isolation
- Trip free mechanism
- Wide range of Internal & External Accessories
- SS Enclosure available
- Standard packing includes insulating phase barriers and hardware



Enclosure for WB MCCB				[HSN Code 8538]
Size	Size Suitable for use on MCCBs	3 Pole Reference*	4 Pole Reference*	MRP (₹)
Frame 1	CSC1, CSC2	CS-CNM0100020-R	-	3195
Frame 2	CSC3	CS-CNM0100021-R	-	3215
Frame 3	CSC4	CS-CNM0100021-R	-	3215
Frame 4	CSC5	ENCL-250-400AF3-R	ENCL-250-400AF4-R	4990

NOTES : 1. *Reference code is for Enclosure only (without MCCB)
 2. For placing an order for MCCB along with Enclosure, please apply Prefix E- before MCCB Reference Code. For Price please contact nearest Branch Office

FTM (Thermal Magnetic) Release ● Fixed Overload ● Fixed short circuit					[HSN Code: 8536]
Size	Rated Current (Amps)	Breaking capacity Icu at 415V AC	2 Pole Reference	MRP (₹)	
Frame 1	15, 20, 30, 40, 50	18kA	CSC1S2* R	4200	
	60, 75, 100		CSC2N2* R	4250	
Frame 3	150, 175	26kA	CSC4N2* R	10140	
	200		CSC4N2* R	11430	
	250		CSC4N2* R	14940	
Frame 2	15, 20, 30, 40, 50, 60	37kA	☒CSC3S2* R	5550	
	75, 100		☒CSC3S2* R	5580	
	125		CSC3S2* R	5730	



Winbreak1 MCCBs (Conforms to IS/IEC 60947-2)

Breaking Capacity : 25kA, 36kA, 50kA

ATM (Thermal Magnetic) Release Adjustable Overload 80-100% Adjustable Short Circuit 5-10 In						
Size	Rated Current (Amps)	Breaking capacity Icu at 415V AC	3 Pole Reference	MRP (₹)	4 Pole Reference	MRP (₹)
Frame 1	63, 80, 100	25kA	CSE1M125ATM3P-* R	7520	CSE1M125ATM4P-* R	8560
	125		CSE1M125ATM3P-* R	8370	CSE1M125ATM4P-* R	9990
Frame 2	160		CSE2M250ATM3P-* R	12110	CSE2M250ATM4P-* R	14640
	200		CSE2M250ATM3P-* R	13680	CSE2M250ATM4P-* R	16680
	250		CSE2M250ATM3P-* R	17020	CSE2M250ATM4P-* R	20500
Frame 3	320		CSE3M400ATM3P-* R	25600	CSE3M400ATM4P-* R	29910
	350		CSE3M400ATM3P-* R	25600	CSE3M400ATM4P-* R	29910
	400		CSE3M400ATM3P-* R	25980	CSE3M400ATM4P-* R	31570
Frame 1	63, 80, 100		36KA	CSE1NN125ATM3P-* R	8000	CSE1NN125ATM4P-* R
	125	CSE1NN125ATM3P-* R		9760	CSE1NN125ATM4P-* R	11500
Frame 2	160	CSE2NN250ATM3P-* R		13290	CSE2NN250ATM4P-* R	16900
	200	CSE2NN250ATM3P-* R		15360	CSE2NN250ATM4P-* R	18040
	250	#CSE2SX250ATM3P-* R		19590	#CSE2SX250ATM4P-* R	23380
Frame 3	320t	CSE3N400ATM3P-* R		25280	CSE3N400ATM4P-* R	29690
	350	CSE3N400ATM3P-* R		25780	CSE3N400ATM4P-* R	30230
	400	CSE3N400ATM3P-* R		26120	CSE3N400ATM4P-* R	31920
Frame 1	63, 80, 100	50KA		CSE1S125ATM3P-* R	10540	CSE1S125ATM4P-* R
	125		CSE1S125ATM3P-* R	11090	CSE1S125ATM4P-* R	13890
Frame 2	160		CSE2S250ATM3P-* R	15520	CSE2S250ATM4P-* R	20940
	200		CSE2S250ATM3P-* R	21090	CSE2S250ATM4P-* R	26680
	250		CSE2S250ATM3P-* R	21090	CSE2S250ATM4P-* R	26680
Frame 3	320		CSE3S400ATM3P-* R	27200	CSE3S400ATM4P-* R	31440
	350		CSE3S400ATM3P-* R	27200	CSE3S400ATM4P-* R	31440
	400		CSE3S400ATM3P-* R	28300	CSE3S400ATM4P-* R	32440

- NOTES : 1. While ordering replace "*" by current rating.
 2. All MCCB's are without spreader terminals.
 3. #Icu 50kA(Ics=75% Icu)



MCCBs

Winbreak1 MCCBs - Frame 'S'

- Conforms to IS/IEC 60947-2
- Ics=100%Icu (for 10kA & 18kA)
- Range: 16A-125A
- Breaking capacity: 10kA, 18kA & 25kA
- Compact Size
- Quick free mechanism
- Precise settings
- Termination possibility for unprepared cables
- Flexibility for installation as Horizontal / Vertical
- Standard packing includes insulating phase barrier and hardware



FMU (Thermal Magnetic) Release • Adjustable Overload 80-100% • Fixed short circuit 10In*						
Size	Rating Range (A)	Breaking Capacity Icu at 415V AC	3 Pole - Reference	MRP (₹)	4 Pole - Reference	MRP (₹)
Frame 'S'	16, 20, 25, 32, 40, 50	10kA	CSESK125FMU3P-*AR	2680	CSESK125FMU4P-*AR	3030
	63, 80, 100		CSESK125FMU3P-*AR	3230	CSESK125FMU4P-*AR	4310
	125		CSESK125FMU3P-*AR	3520	CSESK125FMU4P-*AR	4480
	16, 20, 25, 32, 40, 50	18kA	CSESL125FMU3P-*AR	4090	CSESL125FMU4P-*AR	5120
	63, 80, 100		CSESL125FMU3P-*AR	4200	CSESL125FMU4P-*AR	5560
	125		CSESL125FMU3P-*AR	4500	CSESL125FMU4P-*AR	5720
	16, 20, 25, 32, 40, 50	25kA*	CSESMX125FMU3P-*AR	4700	CSESMX125FMU4P-*AR	5710
	63, 80, 100		CSESMX125FMU3P-*AR	4880	CSESMX125FMU4P-*AR	6010
	125		CSESMX125FMU3P-*AR	5130	CSESMX125FMU4P-*AR	6240

NOTES :

1. While Ordering, Replace** by Current Rating.
2. * Ics=75%Icu
3. *From 63-125A



Changeover Switches

On Load Changeover Switches (Back to Back Type)

LT Heavy Duty 4 Pole On Load Changeover Load Break Switch comprising of two compact Switches 63-250A, 415V, 50Hz complete with handle assembly having Door Interlock and Padlocking arrangement.

- Conforms to IS/IEC 60947-3
- Range: 63A-250A, 415V, 50Hz
- Version: 4P
- Modular construction
- Positive Isolation
- Door Interlock and Padlock facility



In Open Execution					[HSN Code: 8536]
Size	Rating (Amps)	Pole	Reference	MRP (₹)	
NM-Series	Frame 1	63	4	CSCS63NM4CORE	6160
	Frame 1	100	4	CSCS100NM4CORE	8170
	Frame 2	125	4	CSCS125NM4CORE	12230
	Frame 2	160	4	CSCS160NM4CORE	13440
	Frame 2	200	4	CSCS200NM4CORE	16170
	Frame 2	250	4	CSCS250NM4CORE	19780
In Sheet Steel Enclosure					[HSN Code: 8536]
Size	Rating (Amps)	Pole	Reference	MRP (₹)	
NM-Series	Frame 1	63	4	E-CSCS63NM4CORE	8600
	Frame 1	100	4	E-CSCS100NM4CORE	11100
	Frame 2	125	4	E-CSCS125NM4CORE	16510
	Frame 2	160	4	E-CSCS160NM4CORE	17980
	Frame 2	200	4	E-CSCS200NM4CORE	20800
	Frame 2	250	4	E-CSCS250NM4CORE	25850

Changeover Switches



Off-load Changeover Switch				
Reference	Rating(Amps)	Pole	Rated Voltage	MRP (₹)
CSCSOF32CO2RE	32	2	240 V	1930
CSCSOF63CO2RE	63	2	250 V	3750
CSCSOF32CO4RE	32	4	415 V	3250
CSCSOF63CO4RE	63	4	415 V	6630
CSCSOF100CO4RE	100	4	415 V	13130
CSCSOF200CO4RE	200	4	415 V	19900
CSCSOF315CO4RE	315	4	415 V	25590
CSCSOF400CO4RE	400	4	415 V	29420



Switch Fuse Unit: Rewirable				
Reference	Rating(Amps)	Pole	Rated Voltage	MRP (₹)
TPN with Side Handle				
<input checked="" type="checkbox"/> CSRW16P1NSRE	16	SPN	240 V	750
<input checked="" type="checkbox"/> CSRW32P1NSRE	32	SPN	240 V	1870
<input checked="" type="checkbox"/> CSRW16P2SRE	16	DP	240 V	780
CSRW32P2SRE	32	DP	240 V	1970
CSRW32P3NSRE	32	TPN	415V	2950
CSRW63P3NSRE	63	TPN	415V	6140
CSRW100P3NSRE	100	TPN	415V	11640
CSRW200P3NSRE	200	TPN	415V	18430



Porcelain Rewirable Fuse Holder (Kit-Kat)				
Reference	Rating (Amps)	Fuse Wire Size (Max.)	MRP (₹)	MOQ
CSKTRW32RE	32	22SWG	280	3
CSKTRW63RE	63	18SWG	443	
CSKTRW100RE	100	14SWG	890	
CSKTRW200RE	200	2 X14SWG	1835	1

non stockable items.



Switch Disconnectors

Switch Disconnectors (Load Break Switches)

- Conforms to IS/IEC 60947-3
- Range: 25A-400A, 415V AC 50Hz
- Version: TP / 4P
- Compact Construction
- Door Interlock and Padlock facility
- Positive Isolation



[HSN Code: 8536]

Size	Rating Amps	Pole	CSSD In Open Execution		In Sheet Steel Enclosure		
			Reference	MRP (₹)	Reference	MRP (₹)	
D-Series	Frame 1	25	3	CSSD25D3RE	1730	<input type="checkbox"/> E-CSSD25D3RE	3610
			4	<input type="checkbox"/> CSSD25D4RE	2190	E-CSSD25D4RE	3930
	Frame 1	40	3	CSSD40D3RE	1770	E-CSSD40D3RE	4250
			4	CSSD40D4RE	3450	<input type="checkbox"/> E-CSSD40D4RE	4540
	Frame 2	63	3	CSSD63K3RE	2670	<input type="checkbox"/> E-CSSD63K3RE	5020
	Frame 3		4	CSSD63D4RE	3760	<input type="checkbox"/> E-CSSD63D4RE	5950
Frame 3	125	3	CSSD125D3RE	5950	E-CSSD125D3RE	8310	
Frame 3		4	CSSD125D4RE	7240	<input type="checkbox"/> E-CSSD125D4RE	9240	
NM-Series	Frame 1	125	3	CSSD125NM3RE	6200	E-CSSD125NM3RE	9160
			4	CSSD125NM4RE	7640	E-CSSD125NM4RE	11300
	Frame 1	160	3	<input type="checkbox"/> CSSD160NM3RE	6910	E-CSSD160NM3RE	10230
			4	<input type="checkbox"/> CSSD160NM4RE	8230	E-CSSD160NM4RE	12190
	Frame 1	200	3	<input type="checkbox"/> CSSD200NM3RE	8830	E-CSSD200NM3RE	11470
			4	CSSD200NM4RE	11450	E-CSSD200NM4RE	14890
	Frame 1	250	3	CSSD250NM3RE	8930	E-CSSD250NM3RE	13220
			4	CSSD250NM4RE	12390	<input type="checkbox"/> E-CSSD250NM4RE	18350
	* Frame 2	315	3	CSSD315NM3RE	11640	E-CSSD315NM3RE	POR
			4	CSSD315NM4RE	12560	E-CSSD315NM4RE	
* Frame 2	400	3	CSSD400NM3RE	13950	E-CSSD400NM3RE		
		4	CSSD400NM4RE	16920	E-CSSD400NM4RE		

NOTE:

1. Rotary Handle with door defeat Mechanism / Pistol grip handle is available only for 25-63A.
2. Switch Disconnector with Direct Handle and Extended Terminals are also available. Please contact nearest Branch Office for prices.
3. non stockable items.

non stockable items.



Switch Disconnecter Fuse Units

Switch Disconnecter Fuse Units (without Fuse Links)

- Conforms to IS/IEC 60947-3
- Range: 32~250A, 415V AC 50Hz
- Door Interlock and Padlock facility
- Version: 2P / TP / TPN / 4P
- Modular Construction
- Positive Isolation
- Suitable for DIN & Bolted HRC Fuse Links



[HSN Code: 8537]

Size	Rating Amps	Pole	CSSDF in Open Execution				CSSDF in Sheet Steel Enclosure				Recommended Fuse Links Type (IEC Size)	
			Reference	MRP (₹)	Reference	MRP (₹)	Reference	MRP (₹)	Reference	MRP (₹)	DIN	BS
			DIN		BS		DIN		BS			
Frame 1	32A	2P	CSSDF32D2RE	1850	CSSDF32B2RE	1980					CDFL00 32	CTIA-32 (A2)
		TP	CSSDF32D3RE	2210	CSSDF32B3RE	2110	☒E-CSSDF32D3RE	4430	E-CSSDF32B3RE	4510		
		TPN	CSSDF32D3NRE	2230	CSSDF32B3NRE	2200	E-CSSDF32D3NRE	4510	E-CSSDF32B3NRE	4550		
		4P	☒CSSDF32D4NRE	2870	☒CSSDF32B4FNRE	2880	E-CSSDF32D4FNRE	5010	☒E-CSSDF32B4FNRE	5090		
Frame 1	63A	2P	CSSDF63D2RE	2760	CSSDF63B2RE	2770					CDFL00 63	CTIS-63 (A3)
		TP	CSSDF63D3RE	2960	CSSDF63B3RE	2980	☒E-CSSDF63D3RE	5230	E-CSSDF63B3RE	4980		
		TPN	CSSDF63D3NRE	3120	CSSDF63B3NRE	3140	E-CSSDF63D3NRE	5610	E-CSSDF63B3NRE	5690		
		4P	CSSDF63D4FNRE	3660	CSSDF63B4FNRE	3670	E-CSSDF63D4FNRE	5890	☒E-CSSDF63B4FNRE	5900		
Frame 2	100A	2P	CSSDF100D2RE	5710	CSSDF100B2RE	5910					CDFL00 100	CTCP-100 (A4)
		TP	CSSDF100D3RE	6550	CSSDF100B3RE	6570	E-CSSDF100D3RE	8770	E-CSSDF100B3RE	9090		
		TPN	CSSDF100D3NRE	6900	CSSDF100B3NRE	6920	E-CSSDF100D3NRE	9510	E-CSSDF100B3NRE	9680		
		4P	CSSDF100D4FNRE	8210	☒CSSDF100B4FNRE	8520	E-CSSDF100D4FNRE	10590	☒E-CSSDF100B4FNRE	11050		
Frame 2	125A	2P	CSSDF125D2RE	5870	CSSDF125B2RE	6060					CDFL00 125	CTCP-125 (A4)
		TP	CSSDF125D3RE	7000	☒CSSDF125B3RE	7650	☒E-CSSDF125D3RE	10710	E-CSSDF125B3RE	9920		
		TPN	CSSDF125D3NRE	7380	CSSDF125B3NRE	7410	E-CSSDF125D3NRE	11140	E-CSSDF125B3NRE	11180		
		4P	CSSDF125D4FNRE	9090	CSSDF125B4FNRE	9330	☒E-CSSDF125D4FNRE	11420	☒E-CSSDF125B4FNRE	11860		
Frame 2	160A	2P	☒CSSDF160D2RE	7310	CSSDF160B2RE	7500					CDFL00 160	CTF-160 (B2)
		TP	CSSDF160D3RE	9050	☒CSSDF160B3RE	8520	E-CSSDF160D3RE	11380	E-CSSDF160B3RE	11510		
		TPN	CSSDF160D3NRE	8880	CSSDF160B3NRE	8970	E-CSSDF160D3NRE	12250	☒E-CSSDF160B3NRE	12470		
		4P	☒CSSDF160D4FNRE	10640	☒CSSDF160B4FNRE	11670	E-CSSDF160D4FNRE	15230	E-CSSDF160B4FNRE	16810		
Frame 3	200A	2P	CSSDF200D2RE	8890	CSSDF200B2RE	9340					CDFL1200 / CSDFL1200	CTF-200 (B2)
		TP	CSSDF200D3RE	9790	☒CSSDF200B3RE	10090	☒E-CSSDF200D3RE	13100	E-CSSDF200B3RE	12860		
		TPN	CSSDF200D3NRE	11200	CSSDF200B3NRE	11170	E-CSSDF200D3NRE	13940	E-CSSDF200B3NRE	15080		
		4P	CSSDF200D4FNRE	12370	CSSDF200B4FNRE	13290	☒E-CSSDF200D4FNRE	16400	E-CSSDF200B4FNRE	17260		
Frame 3	250A	2P	CSSDF250D2RE	9760	☒CSSDF250B2RE	10390					CDFL1250 / CSDFL1250	CTKF(B3)
		TP	CSSDF250D3RE	12070	CSSDF250B3RE	11990	☒E-CSSDF250D3RE	15220	E-CSSDF250B3RE	14830		
		TPN	CSSDF250D3NRE	12420	CSSDF250B3NRE	12610	E-CSSDF250D3NRE	16770	E-CSSDF250B3NRE	16900		
		4P	CSSDF250D4FNRE	14180	CSSDF250B4FNRE	14490	☒E-CSSDF250D4FNRE	18430	E-CSSDF250B4FNRE	18840		

☒ non stockable items.



HRC Fuse Links, Fuse Base & Fuse Holders

Range 2A-800A

- Conforms to IS 13703-Part 2
- Conforms to IEC 60269-Part 2
- Range: DIN type (6-630A), 500V, AC 50Hz
Bolted type (2-800A), 415V, AC 50Hz
- High breaking capacity: 80kA



DIN Type HRC Fuse Link				[HSN Code: 8536]
IS/IEC Size	In A	Reference	List Price (₹)	MOQ
00	6, 10, 16, 20, 25, 32, 35	CDFL00*	305	3
1	32, 35, 50, 63	CDFL01*	540	
	80, 100, 125	CDFL01*	540	
	160	CDFL01*	550	
	200	CSDFL1*	575	
	250	CSDFL1*	650	
2	100, 125	CDFL02*	840	
	160, 200	CDFL02*	855	
	250	CDFL02*	855	
	315	CSDFL2*	900	
	400	CSDFL2*	940	
3	315, 400	CDFL03*	1195	
	500	CDFL3*	1490	
	630	CDFL3*	1490	

While ordering, replace "*" by current rating.



Fuse Base for DIN Type Fuse Links (ISI Mark)				[HSN Code: 8536]
IS/IEC Size	In A	Reference	List Price (₹)	MOQ
00	160	CSDFB00RE	350	3
1	250	CSDFB1RE	685	
2	400	CSDFB2RE	930	
3	630	CDFB3RE	1560	



Solid Links				[HSN Code: 8536]
IS/IEC Size	In A	Reference	List Price (₹)	MOQ
00	160	CDSL00RE	455	3
1	250	CDSL1RE	600	
2	400	<input checked="" type="checkbox"/> CDSL2RE	825	
3	630	<input checked="" type="checkbox"/> CDSL3RE	1010	

non stockable items.



WiNtrip MCB - Selection Chart

Appliances	Capacity	AMP	MCB Type
	1.0 T 1.5 T 2.0 T	16A 20A 20A	C Type C Type C Type
	165 L 350 L	3A 4A	C Type C Type
	4500 W 1750 W	25A 10A	B Type B Type
	750 W	6A	B Type
	1200 W	10A	B Type
	1500 W	10A	B Type
	750 W	6A	B Type
	4000 W	20A	B Type
	200 W	2A	C Type
	1300 W	10A	C Type

Data is for reference only. Please refer to the appliance manufacturer technical manual for exact appliance current rating.

Safe | **Convenient** | **Energy Saving** | **Wide range**



24x7

SERVICE DESK

CENTRAL CUSTOMER SERVICES (CCS)

C&S Electric is committed to create a unique alchemy of outstanding products, operational excellence, path breaking customer services & compelling marketing. Further to enhance the post sales customer service experience, C&S introduces a service tracking software "C&S Service Desk 24x7". The software provides a transparent service tracking system and helps in efficient monitoring and quick resolution of queries.

Key Features & Benefits

- Transparent process
- Efficient monitoring & tracking of each Service Request
- Quick resolution time
- All relevant customer data in one single location
- Improved customer relationships
- Strengthen C&S brand image & reputation in the market

FOR QUICK SUPPORT

Toll Free Number: 1800 572 2012

WhatsApp No.: 95994 45253

Email: customercare@cselectric.co.in

Connect with right 'Service Expert'

LV SWITCHBOARD

Motor Control center (MCC),
Power Control Center (PCC) etc.

PROTECTION & MEASUREMENT DEVICES

Relay, Meter, Power Factor Controller, etc.

FINAL DISTRIBUTION PRODUCT

MCB, RCCB, Distribution Board

CONTROLGEAR

Contactors, MPCB, Starter,
Push button,
Industrial Plug & Sockets

SWITCHGEAR

ACB, MCCB, Fuse,
Switches, Changeover

OUT OF WARRANTY / PAID SERVICE JOB

cnspaidservices.ccc@cselectric.co.in
ccc@cselectric.co.in

WIRING ACCESSORIES

Wire, Switches-Primo, Divino & Combi

CENTRAL CUSTOMER CARE

A, 7 & 8, Sector - 8, Noida - 201301 Uttar Pradesh

Dedicated Customer Care Centre

65+

Service Centres

50+

C&S Service Experts

50+

C&S Certified Technicians

Escalation Matrix

*C&S Branch Service Engineer ≥ 24 Hours

*Central Customer Services (CCS) ≥ 48 Hours
Toll Free No.: 1800 572 2012, WhatsApp: 9599445253,
Email: customercare@cselectric.co.in

Mr. Bikram Singh Rana - Head Services ≥ 72 Hours
Mobile: 84489 60912
Email: bikram.rana@cselectric.co.in

Mr. P. Anandan ≥ 96 Hours
Sr. VP, Head-Operations & Marketing
Email: anandan.p@cselectric.co.in





Marketing Offices spread all over India

CENTRAL MARKETING OFFICE

222, Okhla Industrial Estate, Phase - III, New Delhi - 110 020

Ph. : (+91 11) 3384 9000 - 09 • Fax : (+91 11) 26847342 • E-Mail : cmo@cselectric.co.in

CUSTOMER CARE

Toll Free Number: 1800 572 2012

E-mail: customercare@cselectric.co.in

NORTHERN REGION

DELHI

Ph. : (+91 11) 3384 9000 - 09

Fax : (+91 11) 26847342

E-Mail : cmo@cselectric.co.in

CHANDIGARH

Ph. : (+91 172) 3021144

Fax : (+91 172) 2631059-3201144

E-Mail : chandigarh@cselectric.co.in

LUDHIANA

Ph. : (+91 161) 2541900, 2541800

Fax : (+91 161) 2541900, 2541800

E-Mail : ludhiana@cselectric.co.in

LUCKNOW

Ph. : (+91 522) 3917843, 4102044

E-Mail : lucknow@cselectric.co.in

KANPUR

Ph. : (+91 522) 3917843, 4102044

E-Mail : kanpur@cselectric.co.in

JAIPUR

Ph. : (+91 141) 4037651

Fax : (+91 141) 4033954

E-Mail : jaipur@cselectric.co.in

CENTRAL REGION

INDORE

Ph. : (+91 731) 4035761, 3918020

E-Mail : indore@cselectric.co.in

RAIPUR

Ph. : (+91 771) 4061404

E-Mail : raipur@cselectric.co.in

NAGPUR

Ph. : (+91 712) 2565215 , 2547295

Fax : (+91 712) 2528923

E-Mail : nagpur@cselectric.co.in

EASTERN REGION

KOLKATA

Ph. : (+91 33) 22275850 - 51

Fax : (+91 33) 22275849

E-Mail : kolkata@cselectric.co.in

GUWAHATI

Ph. : (+91 361) 2469950

E-Mail : guwahati@cselectric.co.in

RANCHI

Ph. : (+91 651) 2242202, 2242224

E-Mail : ranchi@cselectric.co.in

BHUBANESWAR

Ph. : (+91 674) 2580788, 9778070465

E-Mail : bhubaneswar@cselectric.co.in

WESTERN REGION

MUMBAI

Ph. : (+91 22) 24114727-28, 30484071-73

Fax : (+91 22) 24126631

E-Mail : mumbai@cselectric.co.in

AHMEDABAD

Ph. : (+91 79) 30074512 - 14

Fax : (+91 79) 30074519

E-Mail : ahmedabad@cselectric.co.in

BARODA

Ph. : (+91 265) 2339479, 2356293

Fax : (+91 265) 2338754

E-Mail : baroda@cselectric.co.in

PUNE

Ph. : (+91 20) 30283239 - 40

Fax : (+91 20) 30283239

E-Mail : pune@cselectric.co.in

SURAT

Ph. : (+91 261) 6544024-28

E-Mail : surat@cselectric.co.in

SOUTHERN REGION

CHENNAI

Ph. : (+91 44) 39180512 - 15

Fax : (+91 44) 39180514

E-Mail : chennai@cselectric.co.in

COIMBATORE

Ph. : (+91 422) 3048406 - 20

Fax : (+91 422) 3048412

E-Mail : coimbatore@cselectric.co.in

KOCHI

Ph. : (+91 484) 3071715 (10 LINES)

Fax : (+91 484) 3071716

E-Mail : cochin@cselectric.co.in

MADURAI

E-Mail : commercial.madurai@cselectric.co.in

BENGALURU

Ph. : (+91 80) 30570365 / 364

Fax : (+91 80) 25594939

E-Mail : bangalore@cselectric.co.in

SECUNDERABAD

Ph. : (+91 40) 39182478 - 480

Fax : (+91 40) 27812987

E-Mail : hyderabad@cselectric.co.in

VIJAYAWADA

Ph. : (+91 866) 2496265 / 67

E-Mail : vijayawada@cselectric.co.in

RESIDENT ENGINEERS

Agra | Allahabad | Aurangabad | Bareilly | Bhopal | Dehradun | Goa | Gorakhpur | Haridwar | Hubli | Jabalpur | Jammu | Kolhapur | Kollam
Mangalore | Mehsana | Nashik | Patna | Rajkot | Rourkela | Siliguri | Srinagar | Tirupathi | Trichy | Udaipur | Una | Vapi | Visakhapatnam

WAREHOUSES

NATIONAL WAREHOUSE

NOIDA - B-58, Sector-80, Phase-II, Noida - 201305 (UP) Ph.: (+91 120) 3857483/84/88/89

REGIONAL WAREHOUSES

INDORE Liberty Agencies 53, Udyog Nagar, Near Musakhedi Square, Ring Road, Indore-452001 Ph.: (+91) 88780-62000 / 64000

RANCHI Plot No. 145/C, Mandir Marg-D, Road No. 4, Ashok Nagar, Distt. Ranchi, Jharkhand - 834002 Ph.: (91 651) 2242202, 2242224

AHMEDABAD B-25-B/C Meldi Industrial Estate, Opp. West Coast Pharmaceutical, Nr. Gota Over Bridge, Gota, Ahmedabad - 382481 Ph.: (+91 79) 65453044

BENGALURU No. 17, 1st Main Road, Sampangiram Nagar, Bengaluru - 560 027 Ph.: (+91 80) 41125467

